

Register your product and get support at
www.philips.com/welcome

02

English

ENERGICA

Type HD8852

USER MANUAL



EN

02

PLEASE READ THIS USER MANUAL CAREFULLY BEFORE USING THE MACHINE.

CE

 **Saeco**

IMPORTANT SAFEGUARDS

When using electrical appliances, basic safety precautions should always be followed, including the following:

1. Read all instructions.
2. Do not touch hot surfaces. Use handles or knobs.
3. To protect against fire, electric shock and injury to persons do not immerse cord, plugs, or appliance in water or other liquid.
4. Close supervision is necessary when the appliance is used by or near children.
5. Unplug from outlet when not in use and before cleaning. Allow to cool before putting on or taking off parts, and before cleaning the appliance.
6. Do not operate any appliance with a damaged cord or plug or after the appliance malfunctions, or has been damaged in any manner. Return appliance to the nearest authorized service facility for examination, repair or adjustment.
7. The use of accessory attachments not recommended by the appliance manufacturer may result in fire, electric shock or injury to persons.
8. Do not use outdoors.
9. Do not let cord hang over edge of table or counter, or touch hot surfaces.
10. Do not place on or near a hot gas or electric burner, or in a heated oven.
11. Always attach plug to appliance first, then plug cord into wall outlet. To disconnect, turn any control to "off", then remove plug from wall outlet.
12. Do not use appliance for other than intended use.
13. Save these instructions.

SAVE THESE INSTRUCTIONS

CAUTION

This appliance is for household use only. Any servicing, other than cleaning and user maintenance, should be performed by an authorized service center. Do not immerse machine in water. To reduce the risk of fire or electric shock, do not disassemble the machine. There are no parts inside the machine serviceable by the user. Repair should be done by authorized service personnel only.

1. Check voltage to be sure that the voltage indicated on the nameplate corresponds with your voltage.
2. Never use warm or hot water to fill the water tank. Use cold water only.
3. Keep your hands and the cord away from hot parts of the appliance during operation.
4. Never clean with scrubbing powders or harsh cleaners. Simply use a soft cloth dampened with water.
5. For optimal taste of your coffee, use purified or bottled water. Periodic descaling is still recommended every 2-3 months.
6. Do not use caramelized or flavored coffee beans.

INSTRUCTIONS FOR THE POWER SUPPLY CORD

- A. A short power-supply cord (or detachable power-supply cord) is to be provided to reduce risks resulting from becoming entangled in or tripping over a longer cord.
- B. Longer detachable power-supply cords or extension cords are available and may be used if care is exercised in their use.
- C. If a long detachable power-supply cord or extension cord is used,
 1. The marked electrical rating of the detachable power-supply cord or extension cord should be at least as great as the electrical rating of the appliance
 2. If the appliance is of the grounded type, the extension cord should be a grounding-type 3-wire cord, and
 3. The longer cord should be arranged so that it will not drape over the counter top or table top where it can be pulled on by children or tripped over.

Congratulations on your purchase of a Saeco Energica Focus full automatic espresso machine!

To fully benefit from the support that Saeco offers, please register your product at www.philips.com/welcome.

This user manual applies to HD8852.

The machine is suitable for preparing espresso coffees using whole coffee beans. It is supplied with a milk carafe so you can prepare perfect cappuccino or latte macchiato in a quick and easy way. In this user manual you will find all the information you need to install, use, clean and descale your machine.

CONTENTS

IMPORTANT	4
Safety instructions	4
Warning	4
Caution	5
Compliance with standards	5
INSTALLATION	6
Product overview	6
General description	7
PREPARING FOR USE	8
Machine packaging	8
Machine installation.....	8
USING THE MACHINE FOR THE FIRST TIME	11
Automatic rinse/self-cleaning cycle	11
Manual rinse cycle.....	11
Measuring and programming water hardness	13
"INTENZA+" water filter installation	15
Replacing the "INTENZA+" water filter.....	17
ADJUSTMENTS	18
Saeco Adapting System.....	18
Adjusting the ceramic coffee grinder.....	18
Adjusting the aroma (coffee strength)	19
Adjusting the dispensing spout.....	20
Adjusting the coffee length	21
ESPRESSO, COFFEE AND LONG COFFEE BREWING	22
Espresso, coffee and long coffee brewing using coffee beans	22
Espresso, coffee and long coffee brewing using pre-ground coffee.....	23
MILK CARAFE	25
Filling the milk carafe.....	25
Inserting the milk carafe	26
Removing the milk carafe	28
Emptying the milk carafe	28

WATER DISPENSER	29
Inserting the water dispenser	29
Removing the water dispenser.....	29
CAPPUCCINO BREWING	30
Adjusting the cappuccino length.....	32
SPECIAL BEVERAGES	33
Latte Macchiato.....	34
Hot milk	34
Hot water dispensing	35
BEVERAGE PROGRAMMING	36
Cappuccino programming.....	37
Hot water programming	38
MACHINE PROGRAMMING	39
General menu	40
Display menu	40
Water menu	41
Maintenance menu	42
Factory Setting.....	42
CLEANING AND MAINTENANCE	43
Daily cleaning of the machine	43
Daily cleaning of water tank.....	44
Daily cleaning of the milk carafe: AUTO CLEAN cycle (after each use).....	45
Weekly cleaning of the machine	45
Weekly cleaning of the milk carafe	47
Weekly cleaning of the brew group.....	49
Monthly cleaning of the milk carafe.....	51
Monthly lubrication of the brew group.....	54
Monthly cleaning of the brew group with "Coffee Oil Remover".....	55
Monthly cleaning of the coffee bean hopper.....	57
DESCALING	58
MEANING OF THE DISPLAY	62
TROUBLESHOOTING	64
ENERGY SAVING	67
Stand-by	67
Disposal	68
TECHNICAL SPECIFICATION	69
GUARANTEE AND SERVICE	69
Guarantee	69
Service	69
ORDERING MAINTENANCE PRODUCTS	70

IMPORTANT**Safety instructions**

This machine is equipped with safety features. Nevertheless read the safety instructions carefully and only use the machine as described in these instructions to avoid accidental injury or damage.

Keep this user manual for future reference.



The term **WARNING** and this sign warn against possible severe injuries, danger to life and/or damage to the machine.



The term **CAUTION** and this sign warn against slight injuries and/or damage to the machine.

Warning

- Connect the machine to a wall socket which is properly wired. Its main voltage should comply with the technical data of the appliance.
- Do not let the mains cord hang over the edge of a table or counter, or touch hot surfaces.
- Never immerse the machine, mains plug or mains cord in water (danger of electrical shock).
- Never direct the hot water jet towards body parts (danger of burning).
- Do not touch hot surfaces. Use handles and knobs.
- Remove the mains plug from the wall socket:
 - If a disturbance occurs.
 - If the machine will not be used for a long time.
 - Before cleaning the machine.

Pull on the plug, not on the mains cord. Do not touch the mains plug with wet hands.

- Do not use the machine if the mains plug, the mains cord or the machine itself is damaged.
- Do not make any modifications to the machine or its mains cord. Only have repairs carried out by a service centre authorized by Philips to avoid a hazard.
- This machine is not intended for use by persons (including children) with reduced physical, sensory or mental capabilities, or lack of experience and knowledge, unless they have been given supervision or instruction concerning use of the machine by a person responsible for their safety.

- Children should be supervised to ensure that they do not play with the machine.
- Never insert fingers or other objects into the coffee grinder.

Caution

- The machine is for household use only. It is not intended for use in environments such as staff kitchens of shops, offices, farms or other work environments.
- Always put the machine on a flat and stable surface.
- Do not place the machine on a hot plate, directly next to a hot oven, heater or similar source of heat.
- Only put coffee beans into the coffee bean hopper. If ground coffee, instant coffee or any other substance is put in, it may damage the machine.
- Allow the machine to cool before putting on or taking off .
- Never use warm or hot water to fill the water tank. Use cold water only.
- Never clean with scrubbing powders or harsh cleaners. Simply use a soft cloth dampened with water.
- Descale your machine regularly. The machine indicates when descaling is needed. Not doing this will make your appliance stop working properly. In this case repair is not covered under your warranty!
- Do not keep the machine at temperature below 0 degree Celsius. Residue water in the heating system may freeze and cause damage.
- Do not leave water in the water tank when the machine is not used over a longer period of time. The water can become contaminated. Use fresh water every time you use the machine.

Compliance with standards

The machine complies with art.13 of the Italian Legislative Decree dated 25 July 2005, no. 151 "Implementation of the directives 2005/95/EC, 2002/96/EC and 2003/108/EC on the restriction of the use of certain hazardous substances in electrical and electronic equipment, as well as waste disposal".

This machine complies with EU directive 2002/96/EC.

INSTALLATION

Product overview

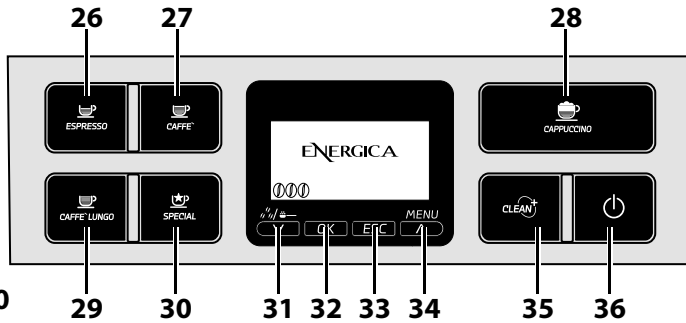
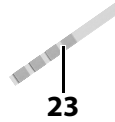
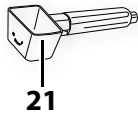
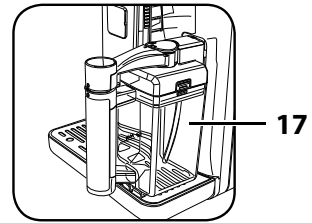
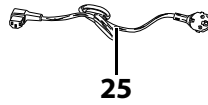
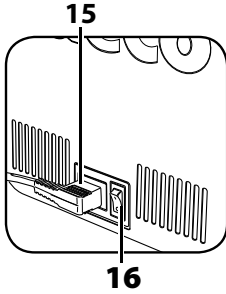
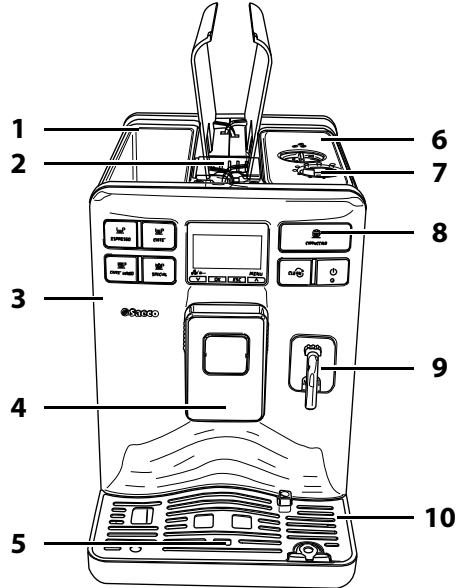
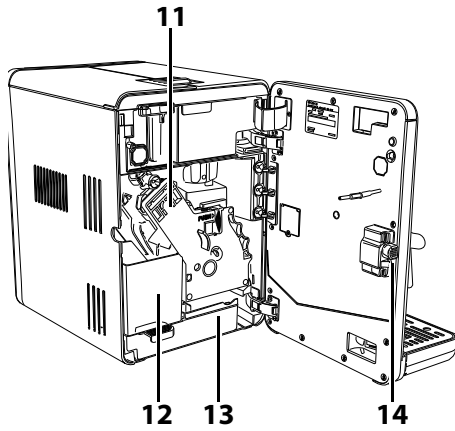

General description

1. Water tank
2. Pre-ground coffee compartment
3. Service door
4. Dispensing spout
5. Full drip tray indicator
6. Coffee bean hopper with lid
7. Grinder adjustment
8. Control panel
9. Hot water dispenser
10. Drip tray (external)
11. Brew group
12. Coffee grounds drawer
13. Drip tray (internal)
14. Service door button
15. Power cord socket
16. Power button
17. Milk carafe
18. Coffee oil remover – to be purchased separately
19. Descaling solution – to be purchased separately
20. INTENZA+ water filter – to be purchased separately
21. Pre-ground coffee scoop
22. Grease for brew group
23. Water hardness test
24. Cleaning brush
25. Power cord
26. Espresso button
27. Coffee button
28. Cappuccino button
29. Long Coffee button
30. "Special beverage" button
31. "Aroma" - Pre-ground coffee button
32. Function button
33. Function button
34. "MENU" button
35. Carafe cleaning cycle activation button (Clean)
36. Stand-by button

PREPARING FOR USE

Machine packaging

The original packaging has been designed and constructed to protect the machine during transport. We recommend keeping the packaging material for possible future transport.

Machine installation

1 Remove the drip tray with grill from the packaging.

2 Remove the machine from the packaging.

3 For best use, it is recommended to:

- Choose a safe, level surface, where there will be no danger of overturning it or being injured.
- Choose a location that is sufficiently well-lit, clean and near an easily reachable socket.
- Allow for a minimum distance from the sides of the machine as shown in the illustration.

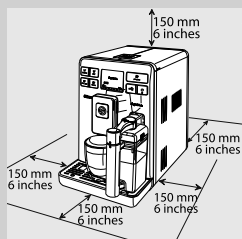

4 Attach the drip tray (external) with grill to the machine. Make sure it is placed correctly.



Note:

The drip tray collects the water that comes out of the dispensing spout during each rinse/self-cleaning cycle as well as coffee that might be spilled during beverage preparation. Empty and clean the drip tray daily and each time the full drip tray indicator is raised.

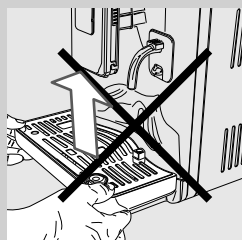

Caution:

NEVER remove the drip tray when the machine has just been turned on. Wait a couple of minutes, since the machine will carry out a rinse/self-cleaning cycle.

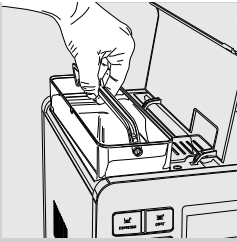

5 Open the lid and remove the water tank by the handle.

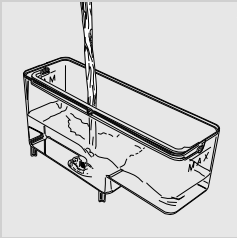

6 Rinse the water tank under fresh water.

7 Fill the tank with fresh water up to the MAX level and re-insert it into the machine. Make sure it is fully inserted.

! **Caution:**

Never fill the water tank with warm, hot, sparkling water or any other liquid, as this may cause damage to the water tank and the machine.

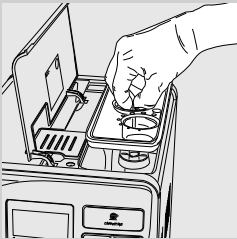

8 Open the lid of the coffee bean hopper and take out the inner lid.

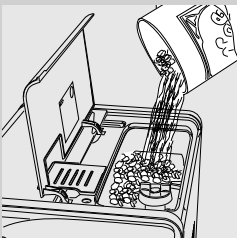

9 Slowly pour coffee beans into the hopper. Put the inner lid back and close the lid.

≡ **Note:**

Do not pour too many coffee beans into the coffee bean hopper as this will reduce the grinding performance of the machine.

! **Caution:**

Only coffee beans must be put into the coffee bean hopper. Ground coffee, instant coffee, caramelized coffee or any other object may damage the machine.

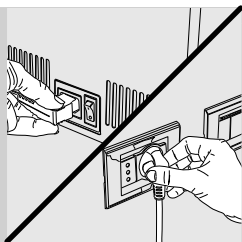

10 Insert the plug into the socket located on the back of the machine.

11 Insert the plug on the other end of the power cord into a wall socket with suitable power voltage.

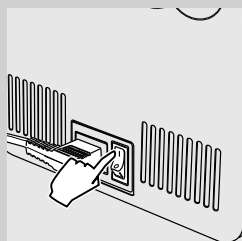

12 Switch the power button to "I" to turn on the machine.

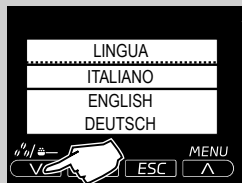

14 This page will be displayed. Select the desired language by pressing the scrolling buttons "V" or "^".



15 Press the "OK" button to confirm.



Note:

If no language is selected, you will be requested to select it the next time the machine is started.

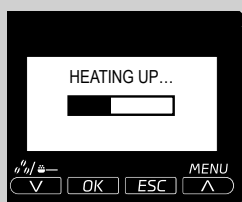

16 The machine is heating-up.

USING THE MACHINE FOR THE FIRST TIME

Automatic rinse/self-cleaning cycle

When warm-up is completed, the machine automatically performs a rinse/self-cleaning cycle of the internal circuit with fresh water. This takes less than a minute.

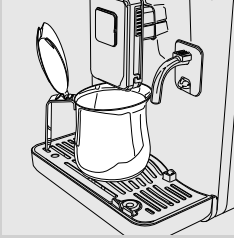

- 17** Place a container under the dispensing spout to catch the small amount of water which will be dispensed.

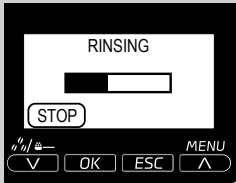

- 18** This page will be displayed. Wait for the cycle to finish automatically.



Note:

You can stop dispensing by pressing the "✓" button.



- 19** When the above steps are complete, the machine shows this display.

Manual rinse cycle

You need to initiate this, when using the machine for the first time. During this process you activate the coffee brewing cycle and fresh water flows through the dispensing spout. This takes a few minutes.

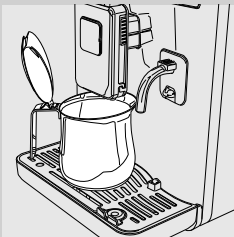

- 1** Place a container under the dispensing spout.

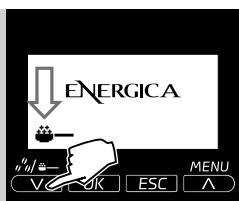

2 Select the pre-ground coffee brewing function by pressing the “☕/☕-” button. The machine shows this icon.



3 Press the “☕☕ CAFFE LUNGO ” button.

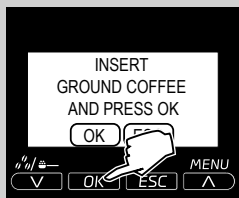

4 Press the “OK” button. The machine starts dispensing water.



Note:

Do not add pre-ground coffee into the compartment.



5 When the dispensing has finished, empty the container and place it under the water dispenser.



6 Press the “☕☕ SPECIAL ” button.



7 Press the “V” button to scroll the pages. Press “OK” to select HOT WATER.



8 Once the water has been dispensed, remove and empty the container.

9 Repeat the process from step 5 to step 8 until the water tank is empty. Then, continue with step 10.

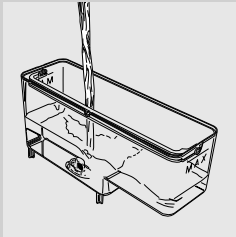

10 At the end, fill the water tank again up to the MAX level. Now the machine is ready for brewing coffee.

Note:

When you haven't used the machine for 2 or more weeks, the machine will automatically perform an automatic rinse/self-cleaning cycle after you switch it on. Thereafter you need to initiate the manual rinse cycle as described above.

The automatic rinse/self-cleaning cycle is also initiated automatically when starting up the machine (with a cold boiler), when the machine is preparing to go into stand-by mode or after you have pressed the "⏻" button to turn off the machine (after a coffee has been brewed).

Measuring and programming water hardness

Measuring water hardness is very important for defining the frequency in which the machine has to be descaled and to install the "INTENZA+" water filter (for more detail on the water filter see next chapter).

To measure the water hardness follow the steps below:

1 Immerse the water hardness test strip provided with the machine in water for 1 second.

Note:

The test strip can only be used for one measurement.

2 Wait for one minute.

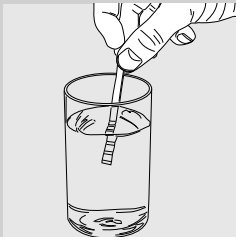

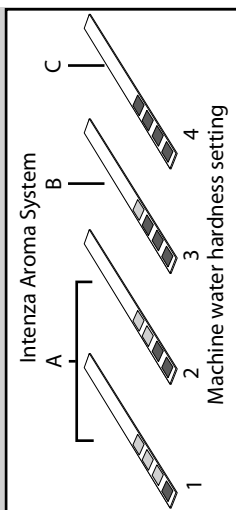

3 Check how many squares have changed the colour to red and then consult the table.

Note:

The numbers on the water hardness test strip correspond to the water hardness adjustment settings.

More precisely:

1 = 1 (very soft water)

2 = 2 (soft water)

3 = 3 (hard water)

4 = 4 (very hard water)

The letters correspond to the references that are located at the base of the "INTENZA+" water filter (see next chapter for this).



4 Now you can program the water hardness setting. Press "MENU" button to access the machine main menu.

Note:

The machine is supplied with standard water hardness setting, suitable for most of the type of water.

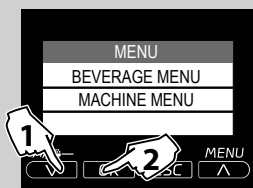

5 Press the "V" button to scroll down the pages. Press "OK" to select MACHINE MENU.

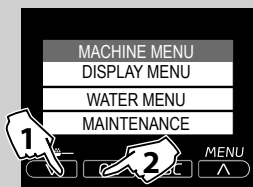

6 Press the "V" button to select WATER MENU. Press "OK" to confirm.

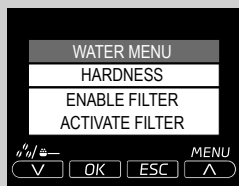

7 Select HARDNESS option by pressing the "OK" button and set the water hardness value.

"INTENZA+" water filter installation

We recommend you to install the "INTENZA+" water filter as this prevents lime scale to build up in your machine and preserves a more intense aroma to your espresso coffee.

You can purchase separately the INTENZA+ water filter. Please refer to the ordering maintenance products chapter in this user manual for further details.

Water is a crucial part of every espresso, so it's most important to always have it professionally filtered. Using the "INTENZA+" water filter will prevent mineral deposits from building up and improve your water quality.

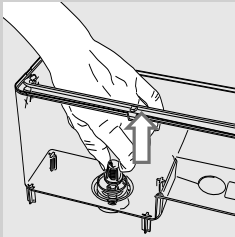

- 1** Remove the small white filter from the water tank and store it in a dry place.



- 2** Remove the "INTENZA+" water filter from its packaging, immerse it vertically (with the opening positioned upwards) in cold water and gently press the sides so as to let the air bubbles out.



- 3** Set the filter according to the measurements performed (see previous chapter) and indicated on the base of the filter:
 A = Soft water – equals 1 or 2 on the test strip
 B = Hard water (standard) – equals 3 on the test strip
 C = Very hard water – equals 4 on the test strip

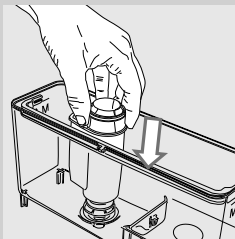

- 4** Put the filter into the empty water tank. Press it until it cannot move further down.

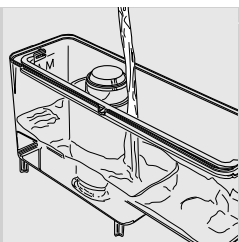

5 Fill the water tank with fresh water and reinsert it into the machine.



6 Place a large container (1,5 lt) under the water dispenser.

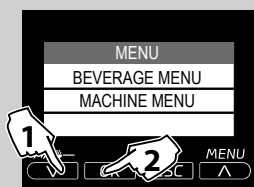

7 Press the "MENU" button to access the machine main menu.

8 Press the "V" button to scroll down the pages. Press "OK" to select MACHINE MENU.

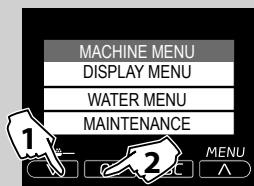

9 Press the "V" button to select WATER MENU. Press "OK" to confirm.

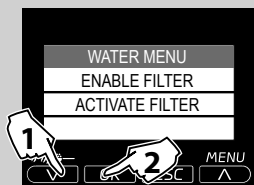

10 Select ACTIVATE FILTER, and then press "OK".



11 Press the "OK" button to confirm that you want to start the filter activation procedure.

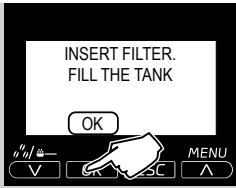

12 Press the "OK" button to confirm that you have inserted the water filter and filled the water tank.



13 The machine reminds you to install the water dispenser. Check that it is correctly installed. Press "OK" to confirm.

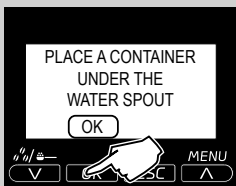

14 Press the "OK" button to confirm that a container is placed under the water spout.

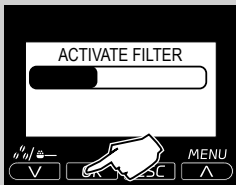

15 The machine starts dispensing water. This page will be displayed. Once the machine stops dispensing, remove the container.

Replacing the "INTENZA+" water filter

When the "INTENZA+" water filter needs to be replaced with a new one, this icon is displayed .

1 Replace the filter as described in the previous chapter.

2 The machine is now programmed to manage a new filter.

 **Note:**

If the filter is already installed and you want to remove - but not replace it, select the "ENABLE FILTER" option and set it to OFF.

If there is no "INTENZA+" water filter installed, insert the small white filter previously removed into the water tank.

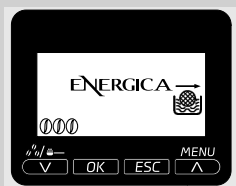

ADJUSTMENTS

The machine allows for certain adjustments so that you can brew the best tasting coffee possible.

Saeco Adapting System

Coffee is a natural product and its characteristics may change according to its origin, blend and roast. The machine is equipped with a self-adjusting system that allows the use of all types of coffee beans available on the market (not for caramelized beans).

The machine automatically adjusts itself after brewing several cups of coffee to optimize the extraction of the coffee to the compactness of the ground coffee.

Adjusting the ceramic coffee grinder

Ceramic coffee grinders always guarantee accurate grinding for every coffee blend and prevent the beans from overheating.

This provides for full aroma preservation, delivering the truly Italian taste in every cup.



Warning:

The ceramic coffee grinder contains moving parts that may be dangerous. Therefore, do not insert fingers and/or other objects. Turn off the machine by pressing the ON/OFF button and remove the plug from the socket before carrying out any type of operation inside the coffee bean hopper.

You can adjust the ceramic grinders to set the coffee grinding to your personal taste.



Warning:

The grinder adjustment knob, inside the coffee bean hopper, must be turned only when the ceramic coffee grinder is working.

This adjustment can be carried out by pressing and turning the grinder adjustment knob inside the coffee bean hopper.

1 Open the lid of the coffee bean hopper.



2 Press and turn the grinder adjustment knob one notch at a time. You will taste the difference after brewing 2-3 cups of espresso.

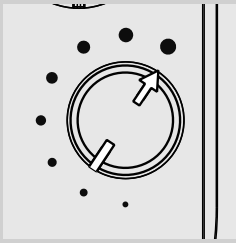

3 The reference marks on the coffee bean hopper lid indicate the grind setting. There are 8 different grind settings to choose from:

- Very coarse grind (●) : lighter taste, for dark roasted coffee blends

To

- Very fine grind (◐) : bolder taste, for light roasted coffee blends

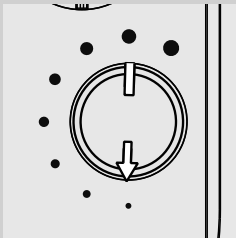

When you adjust the ceramic coffee grinder to a finer setting, your coffee will taste stronger. For a milder coffee taste, adjust the ceramic coffee grinder to a coarser setting.

Adjusting the aroma (coffee strength)

Choose your favorite coffee blend and adjust the amount of coffee to be grounded until they meet your personal taste. You can also select the pre-ground coffee function.



Note:

Selection must be made prior to selecting coffee.

The machine allows you to adjust the right quantity of ground coffee for each product. The standard adjustment for each product can be set in the "BEVERAGE MENU" (see the Beverage Programming chapter, Coffee Quantity option).



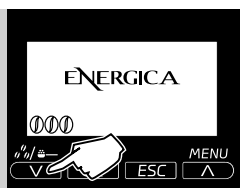

1 To temporarily change the amount of coffee ground, press the "V" button on the control panel.

2 The aroma changes by one degree, according to the selected amount:

0 = mild dose

00 = medium dose

000 = strong dose

 = The beverage is brewed by using the pre-ground coffee

Adjusting the dispensing spout

The height of the dispensing spout can be adjusted to better fit the dimensions of the cups that you wish to use.

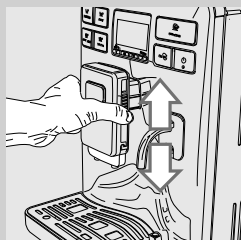

Move the dispensing spout up or down with your fingers to adjust its height as shown in the image.



The recommended positions are:
For the use of small cups;



For the use of large cups;



For the use of latte macchiato cups.



Note:



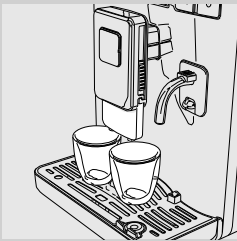

The dispensing spout can also be removed to allow the use of very large containers.





Two cups can be placed under the dispensing spout to brew two cups of coffee at the same time.

Adjusting the coffee length

The machine allows you to adjust the amount of brewed coffee or milk according to your taste and the size of your cups.

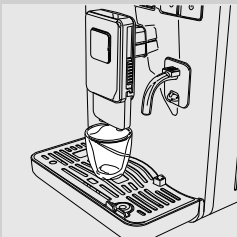
Each time one of the buttons "  " "  " "  " "  " is pressed, the machine brews a pre-set amount of product. Each button may be individually programmed for a specific brew setting.



The following procedure describes the programming of the "  " button.

- 1 Place a cup under the dispensing spout.



- 2 Press and hold the "  " button until the "MEMO" icon is displayed. Then release the button. The machine is now programming. The machine starts brewing coffee.

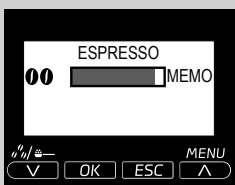



- 3 When the **STOP** icon is displayed, press the “V” button as soon as the desired amount of coffee is reached.

Now the button is programmed; each time it is pressed, the machine will brew the same amount of espresso that was just programmed.



Note:

To program the “” “” “” buttons, the same steps should be followed.

You should always use the “V” button to stop brewing coffee when the desired amount of coffee is reached.

You can also adjust the beverage length through the “BEVARAGE MENU” (see the Beverage Programming chapter, Coffee Length option).

ESPRESSO, COFFEE AND LONG COFFEE BREWING

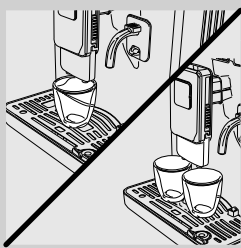

Before brewing coffee, make sure that there are no warnings shown on the display, and that the water tank and coffee bean hopper are filled.

Espresso, coffee and long coffee brewing using coffee beans



- 1 Place 1 or 2 cups under the dispensing spout.



- 2 Press the “” button for an espresso, the “” button for a coffee, the “” button for a long coffee.



- 3 To brew 1 cup of espresso, coffee or long coffee, press the desired button once. This page will be displayed.



- 4 To brew 2 cups of espresso, coffee or long coffee, press the desired button twice consecutively. This page will be displayed.

Note:

In this operating mode, the machine automatically grinds and doses the correct amount of coffee. Brewing two espressos requires two grinding and brewing cycles, automatically carried out by the machine.



- 5 After the pre-brewing cycle, coffee begins to pour out of the dispensing spout.



- 6 Coffee brewing stops automatically when the pre-programmed level is reached; it is possible to stop earlier by pressing "V" button.

Espresso, coffee and long coffee brewing using pre-ground coffee

This function allows to use pre-ground and decaffeinated coffee. With the pre-ground coffee function you can only brew one coffee at a time.





- 1 To select the pre-ground coffee function, press the "V" button until this icon is displayed.



- 2 Place a cup under the dispensing spout.



- 3 Press the “ ESPRESSO” button for an espresso, the “ CAFFÈ” button for a coffee, the “ CAFFÈ LUNGO” button for a long coffee. The brewing cycle starts.



- 4 This page will be displayed.

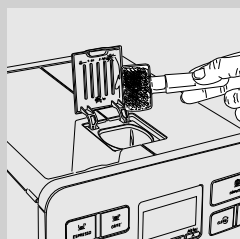

- 5 Lift the pre-ground coffee compartment lid and add one scoop of pre-ground coffee to the compartment. Use only the measuring scoop supplied with the machine. Then close the pre-ground coffee compartment lid.



Warning:

Add only pre-ground coffee to the pre-ground coffee compartment. Other substances and objects may cause severe damages to the machine. Such damages will not be covered by warranty.

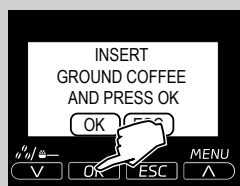

- 6 Press “OK” to confirm and start brewing.

- 7 After the pre-brewing cycle, coffee begins to pour out of the dispensing spout.

- 8 Coffee brewing stops automatically when the pre-programmed level is reached; it is possible to stop earlier by pressing the “V” button.

After brewing the product, the machines returns to the main menu.

Repeat the steps described above to brew more coffees using pre-ground coffee.

**Note:**

If the OK button to start brewing is not pressed within 30 seconds the machine will return to the main menu and discharge any inserted coffee into the coffee grounds drawer.

If no pre-ground coffee is poured into the compartment, only water will be dispensed.

If the dose is excessive and 2 or more measuring scoops of coffee are used, the machine will not brew the product. Only water will be dispensed and any ground coffee will be discharged into the coffee grounds drawer.

MILK CARAFE

This chapter explains how to use a milk carafe to prepare a cappuccino, latte macchiato or hot milk.

**Note:**

Before using the milk carafe, clean it thoroughly as described in the chapter "Cleaning and Maintenance" chapter.

We recommend to fill it with cold milk (approx. 5°C). After use, put the carafe back in the refrigerator. DO NOT leave the milk out of the refrigerator for more than 15 minutes.

**Warning:**

Do not pour any other liquids than water for cleaning or milk.

Filling the milk carafe

The milk carafe needs be filled before use.

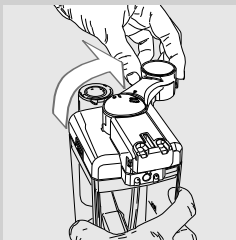

- 1 Open the milk carafe dispenser by turning it clockwise until it locks into place.

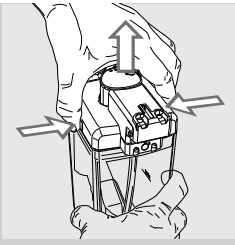

2 Press the release buttons and lift the lid.

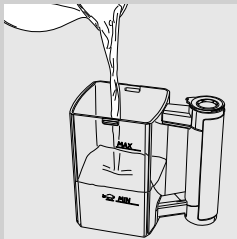

3 Pour the milk into the milk carafe: the milk level must be between the minimum (MIN) and maximum (MAX) level indicator shown on the milk carafe.

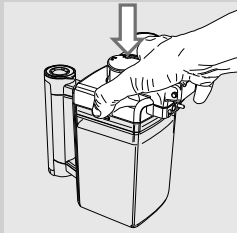

4 Place back the lid and close the milk carafe dispenser by turning it counter clockwise.

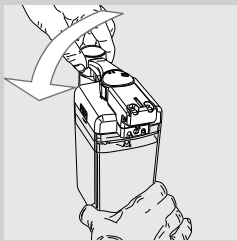

The milk carafe is now ready to use.

Inserting the milk carafe



- 1** If installed, remove the water dispenser as shown in the figure:
- Press the button on the bottom of the water dispenser to unlock it and lift it slightly;



- Pull the water dispenser to remove it.

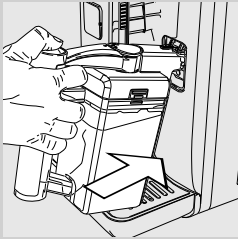

- 2 Slightly tilt the milk carafe and then insert the front part into the machine.

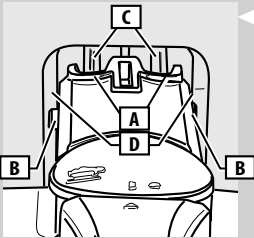

At this stage the carafe holes (A) are lower than the couplings (C). The pins (B) are located at the same height of the guides (D).

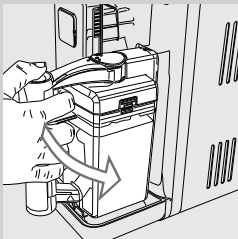

- 3 Push the carafe towards the bottom while rotating at the same time, until it is locked at the (external) drip tray (E).

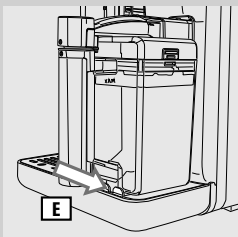

! **Caution:**
Do not use force while inserting the carafe.

Removing the milk carafe

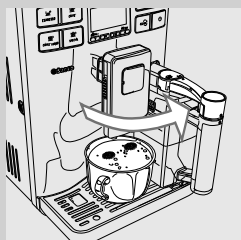

1 Close the milk carafe dispenser by turning it counter clockwise.

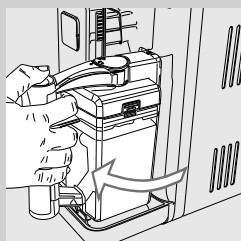

2 Rotate the carafe upwards until it releases from the (external) drip tray (E).

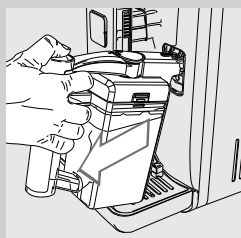

3 Pull away from the machine until it is completely detached.

Emptying the milk carafe

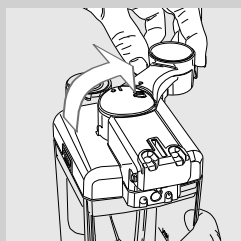

1 Open the milk carafe dispenser by turning it clockwise.

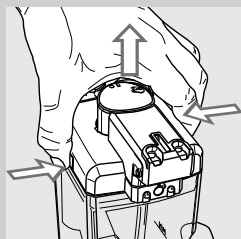

2 Press the release buttons to allow the lid removal.

3 Lift the lid. Empty the milk carafe and clean it properly.



Note:

After each use, clean the milk carafe as described in the "Cleaning and Maintenance" chapter.

WATER DISPENSER

Inserting the water dispenser



- 1 Slightly tilt the water dispenser and then insert it into the guides in the machine.

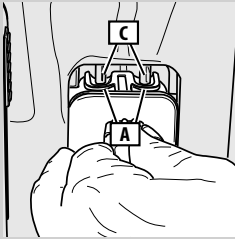

At this stage the dispensing spout holes (A) are lower than the couplings (C). The dispensing spout pins are located at the same height as the guides.



- 2 Push the water dispenser towards the bottom while rotating at the same time, until it is locked in the machine as shown in the figure.



Caution:
Do not use force while inserting the dispenser.

Removing the water dispenser

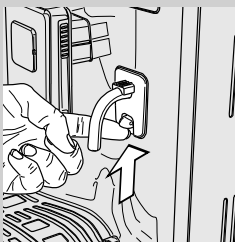

Warning:
Danger of scalding! Dispensing may be preceded by short sprays of hot water and steam. Risk of burning. Wait until the end of the brewing or cleaning cycle before removing the water dispenser.

- 1 Press the button on the bottom of the water dispenser to unlock it and lift it slightly.



- 2 Pull the water dispenser to remove it.

CAPPUCCINO BREWING

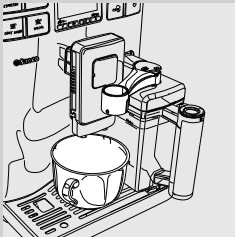
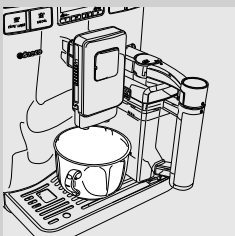
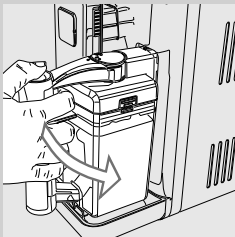
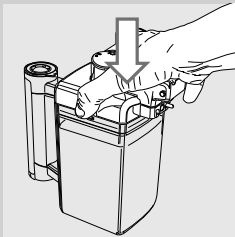
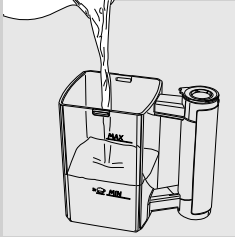
**Warning:**

Danger of scalding! Dispensing may be preceded by short sprays of milk and steam. Risk of burning.
Never seize the carafe handle during the cleaning cycle: risk of scalding! Wait until the end of the cycle before removing the milk carafe.



1 Fill the milk carafe with milk. The level must be between the minimum (MIN) and maximum (MAX) indication on the milk carafe.

**Note:**

Use cold (~5°C / 41°F) milk with a protein content of at least 3% to ensure optimum results when preparing a cappuccino. You can use whole milk or low-fat milk depending on your personal taste.



2 Place back the milk carafe lid and insert the carafe into the machine.



3 Place a cup under the coffee dispensing spout.



4 Open the milk carafe dispenser by turning it clockwise.



5 Press the “” button to start the brewing process.



6 The machine is heating up.



Note:

The machine requires more waiting time for heating up if the ECOMODE is activated. For further details see the chapter MACHINE PROGRAMMING.



7 When the machine shows the following page, the machine pours frothed milk.
The pouring can be stopped earlier by pressing the “MENU” button.



8 Once the milk froth has been poured, the machine pours coffee. The brewing can be stopped earlier by pressing the “V” button.

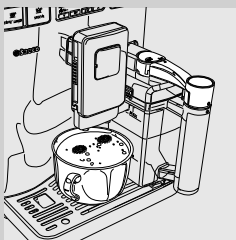

9 Remove the cup and close the milk dispenser by turning it counter clockwise.

10 Wait a few seconds. The machine starts the automatic cleaning process (see the Cleaning and Maintenance chapter).

11 When the cleaning cycle is finished, remove the milk carafe and put it in the refrigerator.

For preparing a latte macchiato or a hot milk, see chapter SPECIAL BEVERAGES.

Adjusting the cappuccino length

Each time the “” button is pressed, the machine brews a pre-set quantity of cappuccino into the cup.

The machine allows you to adjust the amount of cappuccino according to your taste and the size of your cups.

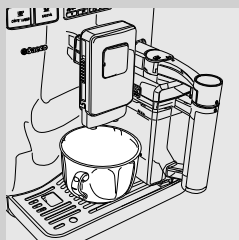

- 1 Fill the milk carafe with milk and install it into the machine.

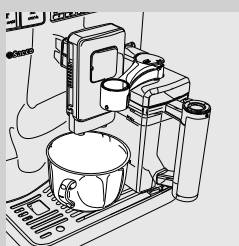

- 2 Place a cup under the dispensing spout and open the milk carafe dispenser by turning it clockwise.



- 3 Press and hold the “” button until the “MEMO” notice appears on the display. Then release the button. The machine is now programming.



- 4 The machine is heating up.



- 5 When the machine shows the following icon, the machine starts to pour milk froth into the cup. When the desired milk froth quantity is reached, press the “MENU” button.

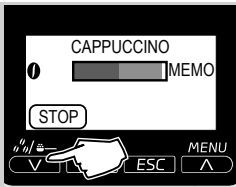

- 6 Once the milk froth has been poured, the machine starts brewing coffee. When the desired coffee quantity is reached, press the "V" button.

Now the "CAPPUCCINO" button is programmed. Every time it is pressed, the machine will brew the same amount that has just been set.

SPECIAL BEVERAGES

The machine is designed to brew more coffee products than the ones described before. For this follow the steps below.



- 1 Press the "SPECIAL" button to enter the SPECIAL BEVERAGES menu.



- 2 Select the desired beverage by pressing the "V" or "∧" scrolling button.

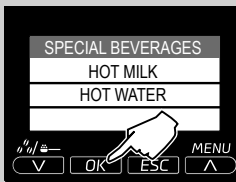

- 3 When the desired beverage has been selected, press the "OK" button to start the preparation.

Note:

When you press the "SPECIAL" button, but do not select a product, the machine returns to the main menu after 10 seconds.

The Special products function allows you to brew only one beverage at a time. To brew more beverages, just repeat steps 1-3.

Latte Macchiato



Warning:

Danger of scalding! Dispensing may be preceded by short sprays of milk and steam. Risk of burning.
Never seize the carafe handle during the cleaning cycle: risk of scalding! Wait until the end of the cycle before removing the milk carafe.

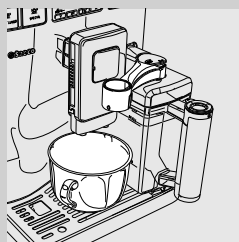

- 1 Insert the milk carafe and place the cup under the dispensing spout. Open the milk dispenser by turning it clockwise.



- 2 Press the "☕
SPECIAL" button to enter the SPECIAL BEVERAGES menu.

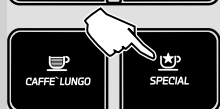

- 3 After selecting "LATTE MACCHIATO" by pressing the "V" or "^" scrolling button, confirm with "OK".
- 4 Once the milk froth has been poured, the machine brews coffee. The brewing can be stopped earlier by pressing the "STOP" button.

Hot milk



Warning:

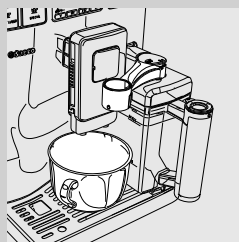

Danger of scalding! Dispensing may be preceded by short sprays of milk and steam. Risk of burning.
Never seize the carafe handle during the cleaning cycle: risk of scalding! Wait until the end of the cycle before removing the milk carafe.

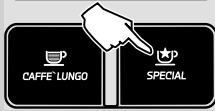

- 1 Insert the milk carafe and place the cup under the dispensing spout. Open the milk dispenser by turning it clockwise.



2 Press the “” button to enter the SPECIAL BEVERAGES menu

3 After selecting “HOT MILK” by pressing the “” or “” scrolling button, confirm with “OK”.

4 The machine starts pouring hot milk. The pouring can be stopped earlier by pressing the “STOP” button.

Hot water dispensing



Warning:

Danger of scalding! Dispensing may be preceded by short sprays of hot water and steam. Risk of burning. Wait until the end of the cycle before removing the water dispenser.



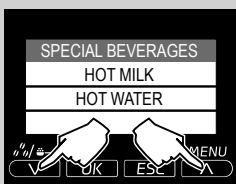

1 Install the water dispenser (please see “Water Dispenser” chapter).

2 Place a container under the water dispenser.



3 Press the “” button to enter the SPECIAL BEVERAGES menu.

4 After selecting HOT WATER by pressing the “” or “” scrolling button, confirm with “OK”.

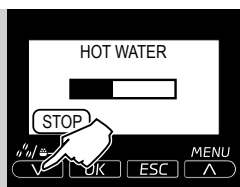

- 5 Hot water is dispensed. The dispensing can be stopped earlier by pressing the "STOP" button.

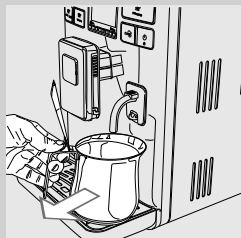

- 6 At the end, remove the container with the desired quantity of water.

After dispensing, some water always remains in the lines and this may result in leaking. This is a normal feature of the machine.

BEVERAGE PROGRAMMING

You can program the machine to optimize the coffee taste to your personal preferences. For each beverage it is possible to customize the settings.

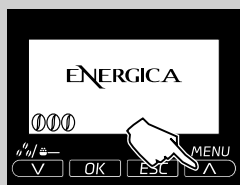

- 1 Press the "MENU" button to access the machine main menu.

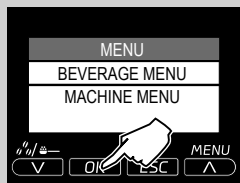

- 2 Press the "OK" button to access the BEVERAGE MENU.



Note:

By pressing the "V" or "^" scrolling button, and confirming with "OK" you can choose the option of your choice.

Cappuccino programming

The following procedure describes the programming of a cappuccino.

Below the settings of the each submenu are explained. You can select these by pressing the "V" or "A" scrolling button. Confirm your settings with "OK".



Press "OK" to select CAPPUCCINO from the beverage menu.

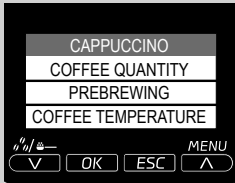

COFFEE QUANTITY

This setting adjusts the amount of coffee which will be ground for beverage brewing.

GROUND COFFEE = The beverage is brewed by using the pre-ground coffee

MILD = mild dose

MEDIUM = medium dose

STRONG = strong dose

PREBREWING

This setting enables the pre-brewing function. During pre-brewing the coffee is slightly dampened to bring out the aroma in full.

OFF: pre-brewing function is not performed.

LOW: pre-brewing function is active.

HIGH: pre-brewing function is longer in order to bring out the coffee taste.

COFFEE TEMPERATURE

This setting adjusts the temperature for coffee brewing.

LOW: low temperature.

NORMAL: medium temperature.

HIGH: high temperature.

COFFEE LENGTH

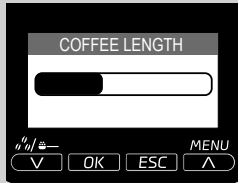

By adjusting the bar on the display by pressing the “V” or “^” scrolling button, you can choose the quantity of water used for coffee brewing. Press “OK” to confirm.

MILK QUANTITY

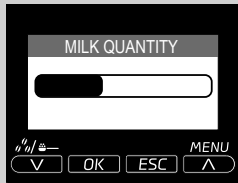

By adjusting the bar on the display by pressing the “V” or “^” scrolling button, you can choose the quantity of milk to be used for the selected beverage. Press “OK” to confirm.

**Note:**

The milk managing options are only shown for beverages with milk.

DEFAULT

For each beverage it is possible to reset the original factory settings. After selecting this function, the customized settings are deleted.

To exit programming, press the “ESC” button one or more times until the main menu is displayed.

Hot water programming

The following procedure describes the programming of hot water.

- 1 Select SPECIAL BEVERAGES from the beverage menu by pressing the “V” or “^” scrolling button. Press “OK” to confirm.





- 2 Select HOT WATER by pressing the “V” or “^” scrolling button. Press “OK” to confirm.

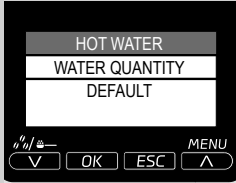

WATER QUANTITY

By adjusting the bar on the display by pressing the “V” or “^” scrolling button, you can choose the quantity of hot water to be dispensed. Press “OK” to confirm.

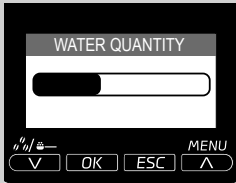

DEFAULT

Reset the original factory settings. After selecting this function, the customized settings are deleted.

MACHINE PROGRAMMING

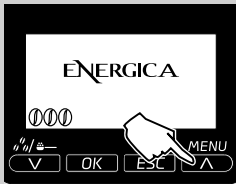

- 1 Press the “MENU” button to access the machine main menu.

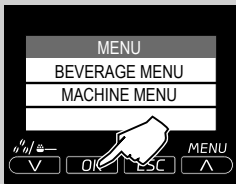

- 2 Select MACHINE MENU by pressing the “V” or “^” scrolling button. Press the “OK” to confirm.

General menu

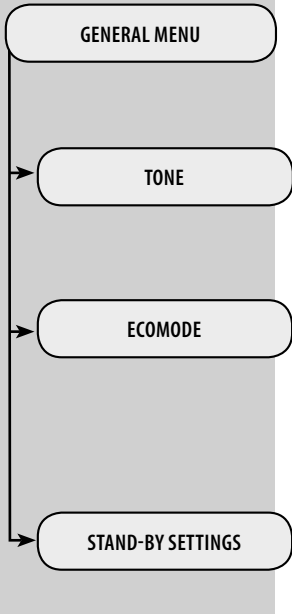
- 

GENERAL MENU The general menu allows you to change the operation settings.
- TONE** The TONE function de-/activates the sound feedback.
- ECOMODE** The ECOMODE enables you to save energy by limiting the boiler activation to one when the machine starts up. If you want to brew more milk beverages, the heating time may be longer. The function is set ON by default.
- STAND-BY SETTINGS** The STAND-BY SETTINGS set the time interval for the machine when to go into stand-by mode after the last brewing. The stand-by time varies from 15, 30, 60 and 180 minutes. The default time value is 30 minutes.

Display menu

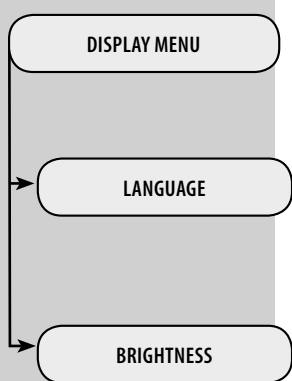
- 

DISPLAY MENU The display menu allows you to set the language and the display brightness.
- LANGUAGE** This setting is important to automatically adjust the parameters of the machine according to your country.
- BRIGHTNESS**

Water menu

WATER MENU

The WATER MENU allows adjusting water parameters for optimal coffee.

HARDNESS

Under HARDNESS, you can set the level of water hardness. To measure water hardness, refer to chapter "MEASURING AND PROGRAMMING WATER HARDNESS"

ENABLE FILTER

By enabling the filter, the machine notifies the user when the water filter needs to be replaced.

OFF: warning disabled.

ON: warning enabled (the warning is automatically set when the filter is activated).

ACTIVATE FILTER

To activate the filter after its installation or replacement. Refer to the chapter "INTENZA+ Water Filter Installation".

Maintenance menu

- 

MAINTENANCE The MAINTENANCE MENU allows setting all the functions for correct machine maintenance.
- COUNTERS** The COUNTERS function shows how many products have been brewed for every single type of coffee since the last reset.
- BREW GROUP CLEAN** The BREW GROUP CLEAN function enables the monthly cleaning of the brew group (please see chapter “Monthly cleaning of the brew group”).
- CARAFE CLEANING** The CARAFE CLEANING function enables the monthly cleaning of the milk carafe (please see chapter “Monthly cleaning of the milk carafe”).
- DESCALING** The DESCALING function activates the descaling cycle (please see chapter “Descaling”).
- CARAFE CLEAN** The CARAFE CLEAN function activates the automatic self-cleaning of the milk carafe. The function is set ON by default.

Factory Setting

- FACTORY SETTINGS** Activating the FACTORY SETTINGS will restore all machine settings to default values. In this case all the personal parameters will be lost.

CLEANING AND MAINTENANCE

Daily cleaning of the machine

**Caution:**

Timely cleaning and maintenance of your machine is very important as it prolongs the life of your machine. Your machine gets exposed to moist, coffee and lime scale continuously!

In this chapter it is described in detail which activities you need to perform at which frequency. Not doing this will ultimately make your machine stop working properly. This repair is NOT covered by your warranty!

**Note:**

- Use a soft, dampened cloth to clean the machine.
- Do not wash any of its parts in the dishwasher.
- Do not use alcohol, solvents, and/or abrasive objects to clean the machine.
- Do not immerse the machine in water.
- Do not dry the machine and/or its components using a microwave and/or standard oven.

Empty and clean the coffee ground drawer and (internal) drip tray daily with the machine turned on. Please follow the steps below:



- 1** Press the button and open the service door.

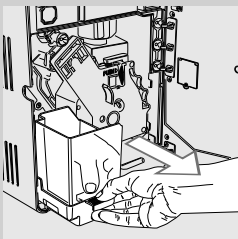

- 2** Remove the (internal) drip tray and coffee grounds drawer.

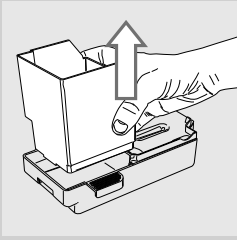

3 Empty the coffee grounds drawer and wash it with fresh water.

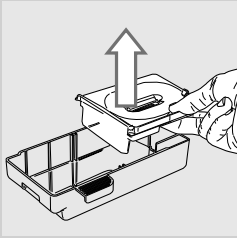

4 Empty and wash the (internal) drip tray and the cover with fresh water.

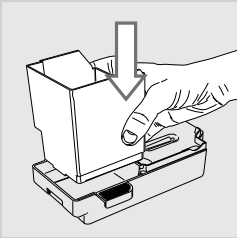

5 Correctly reinstall all the components.

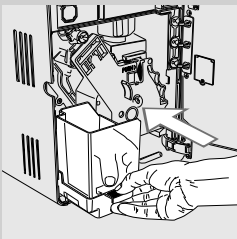

6 Insert the tray and the coffee grounds drawer and close the service door.



Note:

If the coffee ground drawer is emptied when the machine is off, the coffee grounds counter is not reset. In this case the machine might display the "EMPTY COFFEE GROUNDS DRAWER" message too soon.

Daily cleaning of water tank

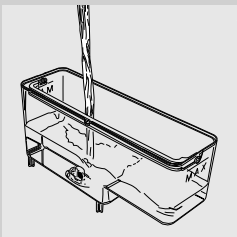

1 Remove the small white filter or the "INTENZA+" water filter (if installed) from the water tank and wash it with fresh water.

2 Put the small white filter back or the "INTENZA+" water filter (if installed) in its housing by gently pressing and turning it at the same time.

3 Fill the water tank with fresh water.

Daily cleaning of the milk carafe: AUTO CLEAN cycle (after each use)

After each brewing of a milk beverage the machine performs an automatic cleaning cycle by routing shots of steam through the milk dispenser.

This cycle may also be manually activated by pressing the "CLEAN" button on the control panel. This can be done at any time.

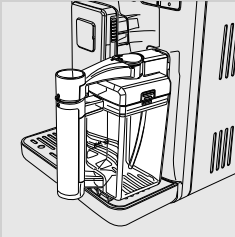

- 1 Insert the milk carafe into the machine as described in the milk carafe chapter. Close the milk dispenser.



- 2 Press the "CLEAN" button to start the cleaning cycle.

Weekly cleaning of the machine

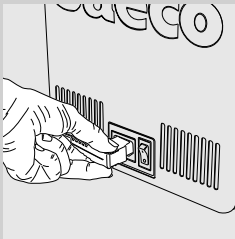

- 1 Turn off the machine and unplug it.

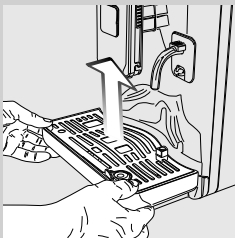

- 2 Take out the (external) drip tray.

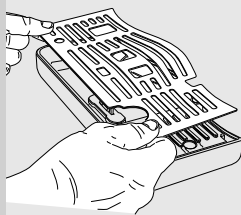

3 Remove the grill and wash it thoroughly.



4 Remove the support under the grill. Wash the support and the drip tray.

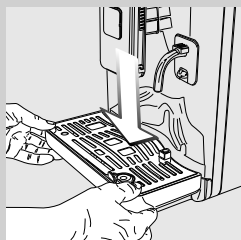

5 Dry, reassemble and reinsert it in the machine.

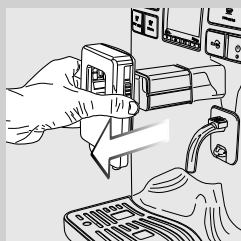

6 Remove the dispensing spout and wash it with water.

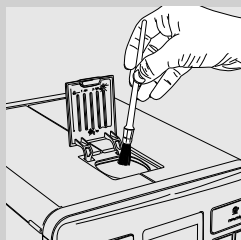

7 Clean the pre-ground coffee compartment with a brush or a dry cloth.



- 8** Wash the hot water dispenser under running water.

Weekly cleaning of the milk carafe

The weekly cleaning is more thorough as it removes any milk residues from the milk dispenser of the carafe.

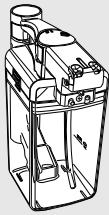

- 1** The carafe must be removed from the machine and emptied before cleaning.



- 2** Open the milk dispenser by rotating it clockwise.

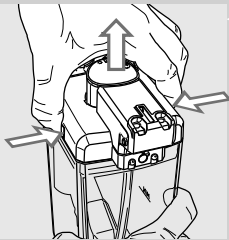

- 3** Press on the sides and lift the lid.

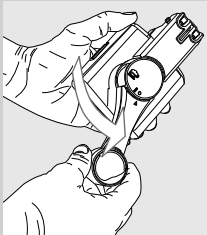

- 4** Rotate the handle counter-clockwise to the unlock position up to the "●" symbol.

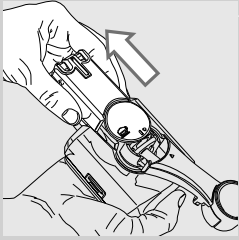

5 Remove the connector which is in contact with the machine.

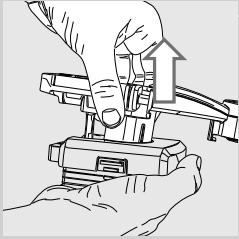

6 Remove the handle with the suction tube.

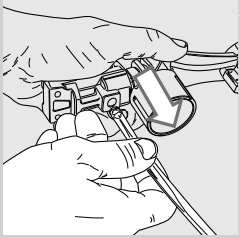

7 Remove the suction tube.

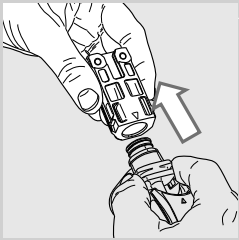

8 Pull out the external fitting.

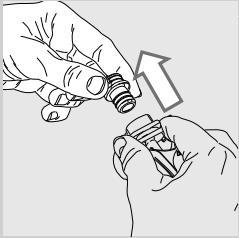

9 Remove the internal fitting.

10 Clean all the parts thoroughly with lukewarm water.

11 Reassemble the parts following the reverse order.



Caution:
Do NOT wash the carafe components in the dishwasher.

Weekly cleaning of the brew group

The brew group should be cleaned every time the coffee bean hopper is filled or at least once a week.



- 1 Press the button and open the service door.

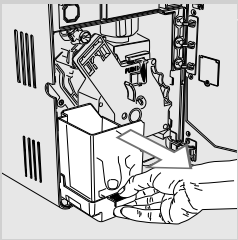

- 2 Remove the (internal) drip tray and coffee grounds drawer.

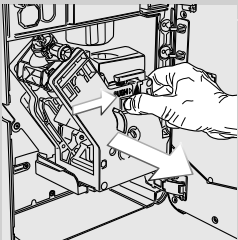

- 3 To remove the brew group, press the «PUSH» button and pull it by the handle.

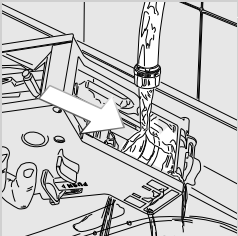

- 4 Thoroughly wash the brew group with fresh, lukewarm water and carefully clean the upper filter.

! **Caution:**

Do not use detergent/soap to clean the brew group.

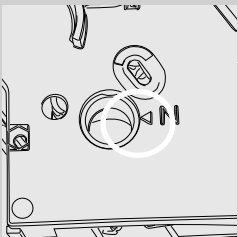

- 5 Let the brew group air-dry thoroughly.
- 6 Thoroughly clean the inside of the machine using a soft, dampened cloth.
- 7 Make sure the brew group is in the rest position; the two reference signs must match. If they do not match, proceed as described in step (8).

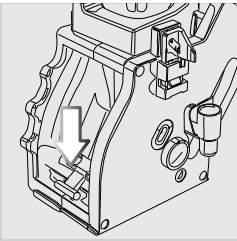

8 Gently pull down the lever until it is in contact with the brew group base and the two reference signs on the side of the brew group do match.

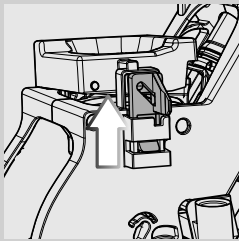

9 Make sure the hook to lock the brew group is in the correct position by firmly pressing the "PUSH" button until you hear a click. Check if the hook is at the top end position. If it is not, please try again.

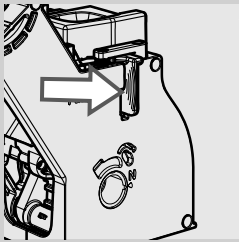

10 Insert the brew group in its seat again until it locks into place without pressing the "PUSH" button.

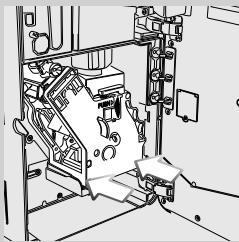

11 Insert the (internal) drip tray and coffee grounds drawer and close the service door.

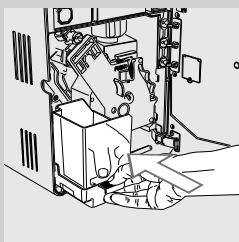

Monthly cleaning of the milk carafe

In the monthly cleaning cycle we use the Saeco Milk Circuit Cleaner to keep the entire circuit clean of milk residues. You can purchase separately the Milk Circuit Cleaner. Please refer to the maintenance products page for further details.



- 1 Select the MAINTENANCE option in the machine menu.
- 2 Select CARAFE CLEANING and press the "OK" button to confirm.

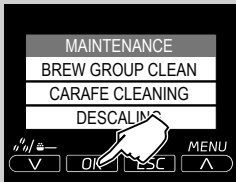

- 3 Press the "OK" button to confirm.



- 4 Fill the tank with fresh water up to the MAX level. Press the "OK" button.

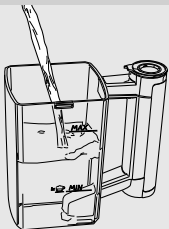

- 5 Fill the milk carafe with fresh drinking water up to the MAX level. Pour one milk cleaner bag into the milk carafe and let it dissolve completely.

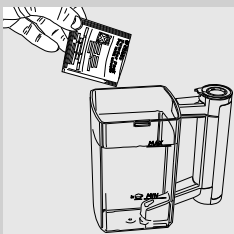

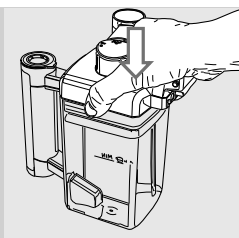

6 Put the lid back on.

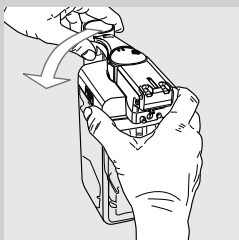

7 Rotate the milk dispenser counter-clockwise to the lock position.

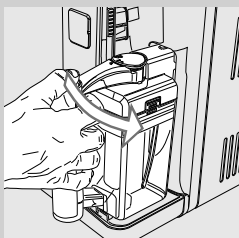

8 Insert the milk carafe into the machine.

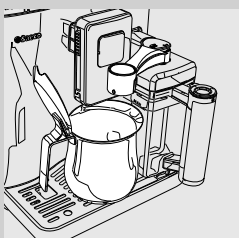
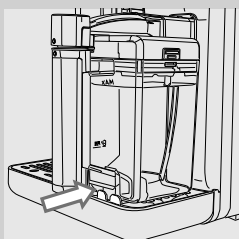

9 Place a large container (1,5 lt) under coffee the dispensing spout. Open the milk dispenser by turning it clockwise.



10 Press the "OK" button to start the cycle. The machine starts dispensing the cleaning solution through the milk dispenser.



11 This icon is displayed. The bar shows the cycle progress.

Warning:
Never drink the solution dispensed during the procedure.



12 When the machine stops dispensing, fill the tank with fresh water up to the MAX level. Press the "OK" button to confirm.

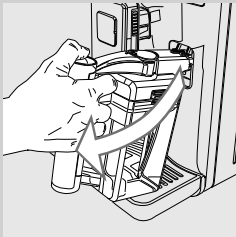

13 Remove the milk carafe and the container from the machine.



14 Wash the milk carafe thoroughly and fill it with fresh water. Insert the milk carafe into the machine. Press the "OK" button to confirm.

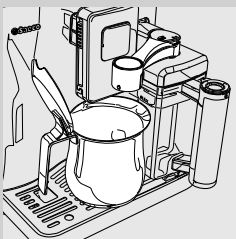

15 Empty the container and place it back under the coffee dispensing spout. Open the milk dispenser by turning it clockwise.

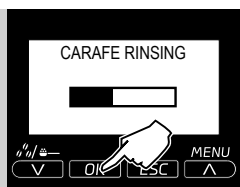

16 The machine starts dispensing water from both the coffee and the milk dispensing spout. The bar shows the cycle progress.

17 At the end of the cycle, the machine returns to the product brew menu page.

18 Disassemble and wash the milk carafe as described in the “Weekly cleaning of the milk carafe” chapter.

Monthly lubrication of the brew group

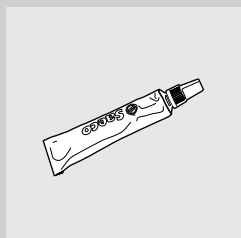

Lubricate the brew group after approximately 500 cups of coffee or once a month.

You can purchase separately the Saeco grease to lubricate the brew group. Please refer to the maintenance products page in this user manual for further details.



Caution:

Before lubricating the brew group, clean it under fresh water and dry it, as described in the “Weekly Cleaning of the Brew Group” chapter.

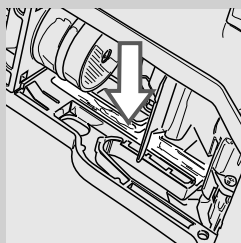

1 Apply the lubricant evenly on both side guides.

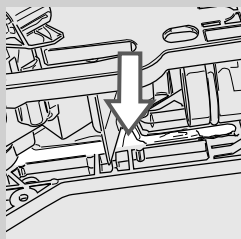

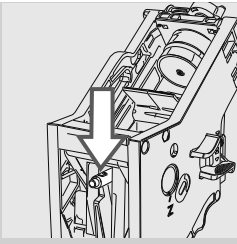

2 Lubricate the shaft too.

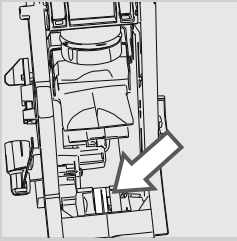

3 Insert the brew group in its seat until it locks into place (see “Weekly Cleaning of the Brew Group” chapter).

4 Insert the (internal) drip tray and coffee grounds drawer and close the service door.

Monthly cleaning of the brew group with “Coffee Oil Remover”



Besides weekly cleaning, we recommend running this cleaning cycle with the “Coffee Oil Remover” after approximately 500 cups of coffee or once a month. This operation completes the maintenance process of the brew group.

You can purchase separately the “Coffee Oil Remover” and the “Maintenance Kit”. Please refer to the maintenance products page for further details.



Caution:

The “Coffee Oil Remover” tablets are to be used for cleaning only and do not have a descaling function. For the descaling procedure use the Saeco descaling solution and follow the procedure described in the “Descaling” chapter.

1 Select the “MAINTENANCE” option in the machine menu.

2 Select “BREW GROUP CLEAN”. Press the “OK” button.





3 Press the "OK" button to confirm.



4 Fill the water tank with fresh water up to the MAX level. Press the "OK" button.

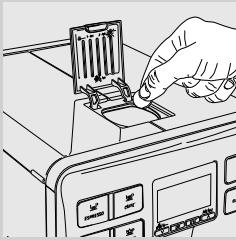

5 Put a "Coffee Oil Remover" tablet in the pre-ground coffee compartment. Press the "OK" button.

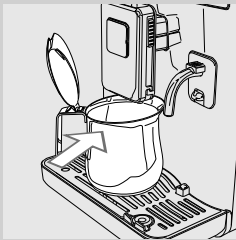

6 Place a container (1,5 lt) under the coffee dispensing spout. Press the "OK" button to start the cleaning cycle.



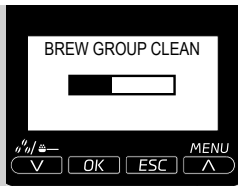

7 This icon is displayed. The bar shows the cycle progress.



Warning:

Never drink the solution dispensed during the procedure.

8 When the machine stops dispensing, remove and empty the container.

9 Clean the brew group as described in the chapter “Weekly Cleaning of the Brew Group”

Monthly cleaning of the coffee bean hopper

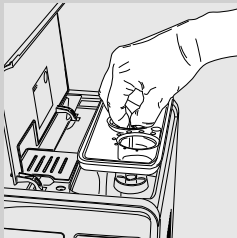

Clean the coffee bean hopper once a month when it is empty with a damp cloth to remove coffee oil. Thereafter refill it with coffee beans.

DESCALING

The descaling process takes approx. 35 minutes.

Lime scale builds up inside the machine during use. It needs to be removed regularly as it may clog the water and coffee circuit of your machine. The machine indicates when descaling is needed.

**Caution:**

Not doing this will ultimately make your machine stop working properly, and in this case repair is NOT covered by your warranty.



Use the Saeco decalcifier only. Its formula has been designed to ensure better machine performance.

You can purchase separately the Saeco decalcifier. Please refer to chapter "Ordering Maintenance Products" for further information.

**Warning:**

Never drink the decalcifier or any products dispensed until the cycle has been carried out to the end. Never use vinegar as a decalcifier.

**Note:**

During the descaling cycle do not switch off the machine. If this has happened, you need to restart the descaling cycle from the very beginning.

To execute the descaling cycle, follow the steps below:

1 In the MACHINE MENU, select the "MAINTENANCE" option.

2 Select "DESCALING" and confirm with "OK".

**Note:**

If you press the "OK" button by mistake, press the "ESC" button to quit.

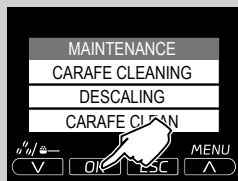

3 Press "OK" button to confirm.





- 4 Remove the water tank, and if installed, remove the INTENZA+ water filter. Pour the entire content of the Saeco decalcifier. Then fill the water tank with fresh water up to the MAX level. Press the "OK" button.



- 5 Empty the (internal) / (external) drip tray. Press the "OK" button.

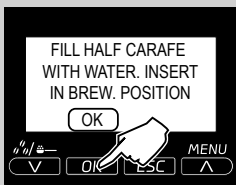

- 6 Fill half the milk carafe with fresh water. Insert the carafe and open the milk dispenser by turning it clockwise. Press the "OK" button.



- 7 Place a large container (1,5 lt) under the coffee and milk dispenser spout of the carafe. Press the "OK" button.

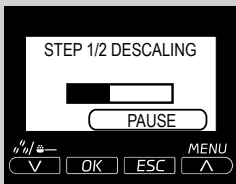

- 8 The machine will start dispensing the descaling solution at intervals. The bar on the display shows the cycle progress.

 **Note:**

To empty the container during the process, the descaling cycle may be paused by pressing the "ESC" button. To resume the cycle, press the "OK" button.



- 9 The message indicates the end of the first step. The water tank needs to be rinsed. Fill the water tank with fresh water up to the MAX level. Press the "OK" button.



10 Empty the (internal) drip tray and place it back. Then, press the “OK” button.

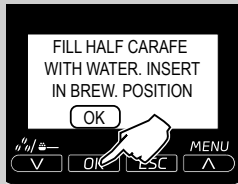

11 Empty the milk carafe and fill it with fresh water. Insert it back in the machine. Press the “OK” button.



12 Empty the container and place it back under the coffee and milk dispensing spout. Press the “OK” button.



13 The rinsing cycle is activated. The bar shows the cycle progress.

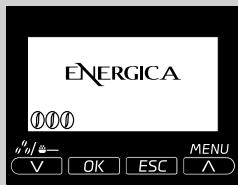

14 When the amount of water needed for the rinse cycle has been completely dispensed, the machine automatically ends the descaling process by showing this display after a short heating up phase.

15 Remove and empty the container.

16 Disassemble and wash the milk carafe as described in the “Weekly cleaning of the milk carafe” chapter.

17 Empty the (internal) drip tray and place it back.

18 Place back the “INTENZA+” water filter into the water tank if it was installed.

19 The descaling cycle is now complete.













Note:

At the end of the descaling cycle, wash the brew group as described in the “Weekly Cleaning of the Brew Group” chapter.

The rinsing cycle is performed in order to have the circuit cleaned with a preset amount of water to ensure proper machine performance. If the water tank is not filled up to MAX level, the machine might require two or more cycles.

MEANING OF THE DISPLAY

Help Message Displayed	How to Reset the Message
	Close the bean hopper inner cover.
	Fill the coffee beans hopper.
	The brew group must be inserted into the machine.
	Insert the coffee grounds drawer and the internal drip tray.
	Empty the coffee grounds drawer.  Note: The used grounds drawer must be emptied only when the machine requires it and with the machine on. If you empty the drawer with the machine turned off it will not record the emptying operation.
	Close the service door.
	Remove the water tank and fill it.
	Open the service door and empty the internal drip tray.  Warning: If this operation is performed when the machine is on, it will record the used grounds drawer emptying and will reset the counter; therefore, it is necessary to empty the coffee grounds as well.

Help Message Displayed

How to Reset the Message



Open the milk dispenser of the carafe to brew products. Press the button "ESC" to exit.



Close the milk dispenser of the carafe to start the rinsing cycle of the carafe. Press the button "ESC" to exit.



Insert the milk carafe to start brewing. Press "ESC" to exit.



The machine needs to be descaled. Follow the steps described in the "Descaling" chapter of this manual. Please note that not descaling your machine will ultimately make it stop working properly. In this case repair is NOT covered under your warranty.



The machine needs the "INTENZA+" water filter to be replaced.



Red light flashes. Press the "⏻" button to exit the stand-by mode.

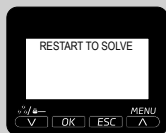

Take note of the code (E xx) shown in the display at the bottom. Turn off the machine. After 30 seconds, turn it on again. Try this 2 or 3 times. If the machine does not start, contact the Philips SAECO hotline in your country and tell them the code shown in the display. You can find its contact details in the warranty booklet by-packed separately or on www.philips.com/support.



Insert the water dispenser to start dispensing. Press "ESC" to exit.

TROUBLESHOOTING

This chapter summarizes the most common problems you could encounter with your machine. If you are unable to solve the problem with the information below, visit www.philips.com/support for a list of frequently asked questions or contact the Philips Saeco hotline in your country. You find its contact details in the warranty booklet by-packed separately or on www.philips.com/support.

Machine actions	Causes	Solutions
The machine does not switch on.	The machine is not connected to the electric network.	Connect the machine to the electric network.
	The power button is set to "0".	Check that the power button is set to "1".
The drip tray gets filled although no water is drained.	Sometimes water is drained automatically by the machine into the drip tray to manage the rinsing of the circuits and ensure optimum machine performance.	This is seen as normal machine behavior.
Coffee is not hot enough.	The cups are cold.	Preheat the cups with hot water or use the hot water dispenser.
	Beverage temperature in the programming menu is set to low.	Ensure that the temperature is set to Normal or High in the beverage programming menu.
	Cold milk is being added to the coffee.	Cold milk will reduce the temperature of the end product. Therefore please pre-heat the milk before adding it.
No hot water is dispensed.	The hot water dispenser is clogged or dirty.	Clean the hot water dispenser (please refer to chapter "Cleaning and maintenance"). Check if it is clogged by looking into the spout. Use a pin or needle to make a hole through the limestone.
The machine is not filling the cup.	The machine has not been programmed.	Enter the beverage programming menu and adjust the coffee length setting to your liking for every beverage.
Coffee has not enough crema. (See note)	The blend is unsuitable, coffee is not freshly roasted or the grind is too coarse.	Change coffee blend or adjust the grind as explained in chapter "Adjusting the ceramic coffee grinder".
	The coffee beans or the pre-ground coffee are too old.	Ensure that fresh coffee beans or pre-ground coffee are being used.
The milk was not frothed.	The Carafe is dirty or not inserted correctly.	Verify the correct cleaning of the carafe and its insertion.

Machine actions	Causes	Solutions
The machine takes a long time to warm up or the amount of water dispensed from the wand is too little.	The machine circuit is clogged by limescale.	Descale the machine.
The brew group cannot be removed.	The brew group is out of place.	Turn the machine on. Close the service door. The brew group automatically returns to the initial position.
	The coffee grounds drawer is inserted.	Remove the coffee grounds drawer before removing the brew group.
The brew group cannot be inserted.	The brew group is not in rest position.	Ensure that the brew group is in rest position. Both arrows must look towards each other. Please refer to chapter "Monthly lubrication of the brew group" how to do that.
	Gear is not in initial position.	Insert the drip tray with the coffee grounds drawer and then close the service door. Turn the machine on. The gear automatically returns to the initial position so the Brew Group can be inserted.
There is a lot of coffee ground under or on the brew group.	The coffee you are using may not be suitable for automatic machines.	It may be necessary to change the type of coffee or the coffee grinder settings (please refer to chapter "Adjusting the ceramic coffee grinder").
	The machine is adjusting the grinder due to new coffee beans or pre-ground coffee.	The machine automatically adjusts itself after brewing several cups of coffee to optimize the extraction of the coffee to the compactness of the ground coffee. It may take up to 2-3 products until the grinder is adjusted. This is not a failure of your machine.
The machine produces coffee grounds that are either too wet or too dry.	The grinder needs to be adjusted.	By adjusting the ceramic coffee grinder, the quality of the puck can be adjusted. When the pucks are too wet, make the grind coarser. When the pucks are too dry, make the grind finer. Please refer to chapter "Adjusting the Ceramic Coffee Grinder".

Machine actions	Causes	Solutions
The machine grinds the coffee beans but no coffee comes out. (See note)	There is no water.	Fill the water tank and prime the circuit (please refer to chapter "Manual rinse cycle").
	The brew group is dirty.	Clean the brew group ("Weekly cleaning of brew group" chapter).
	This might occur when the machine is automatically adjusting the dose.	Brew a few coffees as described in chapter "Saeco Adapting System".
	The dispensing spout is dirty.	Clean the dispensing spout.
Coffee is too weak. (See note)	This might occur when the machine is automatically adjusting the dose.	Brew a few coffees as described in chapter "Saeco Adapting System".
	The coffee is too coarse.	Change coffee blend or adjust the grind as explained in chapter "Adjusting the ceramic coffee grinder".
Coffee is brewed slowly. (See note)	The coffee grind is too fine.	Change coffee blend or adjust the grind as explained in chapter "Adjusting the ceramic coffee grinder".
	Circuits are clogged.	Perform a descaling cycle.
	The brew group is dirty.	Clean the brew group (please refer to chapter "Weekly cleaning of the brew group").
Coffee leaks out of the dispensing spout.	The dispensing spout is clogged.	Clean the dispensing spout and its holes.

**Note:**

These problems can be considered normal if the coffee blend has been changed or if the machine has just been installed. In this case wait until the machine performs a self-adjusting operation as described in chapter "Saeco Adapting System".

ENERGY SAVING

Stand-by

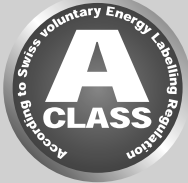

The Saeco full automatic espresso machine is designed for energy saving-proven by the Class A energy label.

After a certain time of inactivity that can be programmed individually (see chapter "Machine Programming"), the machine turns off automatically. If a product has been brewed, the machine performs a rinsing cycle. In stand-by mode, the energy consumption is below 1Wh.

To turn on the machine, press "⏻" button (if power button on the back of the machine is set to "I"). If the boiler is cold the machine performs a rinsing cycle.

The machine status can be manually changed to stand-by mode by holding the STAND-BY button for 3 seconds.

**Note:**

- 1 The stand-by mode cannot be activated if the service door is left open.
- 2 When the stand-by mode is activated, the machine may perform a rinse cycle. The cycle can be interrupted by pressing the "V" button.

The machine can be turned on again by

- 1 pressing any of the control panel buttons.
- 2 opening the service door (when closing the door the machine goes back to standby mode).

The red light on the "⏻" button flashes when the machine is in stand-by mode.



Disposal

Do not throw away the machine with the normal household waste at the end of its life, but hand it in at an official collection point for recycling. By doing this, you help to preserve the environment.

- The packing materials can be recycled.
- Machine: unplug the machine and cut the power cord
- Deliver the appliance and power cord to a service center or public waste disposal facility.

This product complies with EU directive 2002/96/EC.

The symbol on the product or on its packaging indicates that this product may not be treated as household waste.

Instead it shall be handed over to the applicable collection point for the recycling of electrical and electronic equipment.

By ensuring this product is disposed of correctly, you will help prevent potential negative consequences for the environment and human health, which could otherwise be caused by inappropriate waste handling of this product. For more detailed information about recycling of this product, please contact your local city office, your household waste disposal service or the shop where you purchased the product.

TECHNICAL SPECIFICATION

The manufacturer reserves the right to make changes to the technical specifications of the product

Nominal Voltage - Power Rating - Power Supply	See label on the appliance
Housing material	Thermoplastic material
Size (w x h x d)	245 x 360 x 420 mm
Weight	13.4 Kg
Power Cord Length	1200 mm
Control Panel	On the front
Size of cup	110 mm
Water Tank	1.5 liters – Removable type
Coffee bean hopper capacity	300 gr
Coffee grounds drawer capacity	11
Pump pressure	15 bar
Boiler	Stainless steel type
Safety mechanisms	Boiler pressure safety valve – Double safety thermostat.
Safety mechanisms	Thermal fuse

GUARANTEE AND SERVICE

Guarantee

For detailed information on your warranty and related conditions, please read the warranty booklet by-packed separately.

Service

We want to ensure that you remain satisfied with your machine. If not done already, please register your product on www.philips.com/welcome so that we can stay in contact with you and send you cleaning and descaling reminders.

If you need service or support, please visit the Philips website at www.philips.com/support or contact the Philips Saeco hotline in your country. You find its phone number in the warranty booklet by packed separately or on www.philips.com/support.

ORDERING MAINTENANCE PRODUCTS

For cleaning and descaling, use Saeco maintenance products only. You can purchase these at the Philips online shop at www.shop.philips.com/service, your local dealer or at authorised service centers.

If you have any difficulties obtaining maintenance products for your machine, please contact the Philips Saeco hotline in your country.

You find its contact details in the warranty booklet by-packed separately or on www.philips.com/support.

Overview of maintenance products



- Decalcifier CA6700



- INTENZA+ Water Filter CA6702

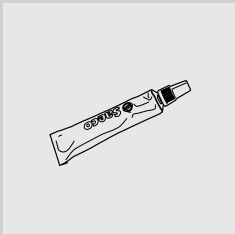

- Grease HD5061



- Coffee Oil Remover CA6704

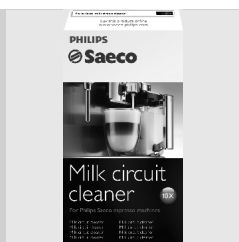

- Milk Circuit Cleaner CA6705



- Maintenance Kit CA 6706



The manufacturer reserves the right to make changes without prior notice.

www.philips.com/saeco

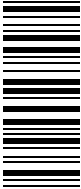

15003638

Rev.02 del 15-09-12