

Register your product and get support at
www.philips.com/welcome

02

English

ROYAL

Type HD8930

OPERATING INSTRUCTIONS



EN

02

READ THESE INSTRUCTIONS CAREFULLY BEFORE USING THE MACHINE.

CE

PHILIPS
Saeco

IMPORTANT SAFEGUARDS

When using electrical appliances, basic safety precautions should always be followed, including the following:

1. Read all instructions.
2. Do not touch hot surfaces. Use handles or knobs.
3. To protect against fire, electric shock and injury to persons do not immerse cord, plugs, or appliance in water or other liquid.
4. Close supervision is necessary when the appliance is used by or near children.
5. Unplug from outlet when not in use and before cleaning. Allow to cool before putting on or taking off parts, and before cleaning the appliance.
6. Do not operate any appliance with a damaged cord or plug or after the appliance malfunctions, or has been damaged in any manner. Return appliance to the nearest authorized service facility for examination, repair or adjustment.
7. The use of accessory attachments not recommended by the appliance manufacturer may result in fire, electric shock or injury to persons.
8. Do not use outdoors.
9. Do not let cord hang over edge of table or counter, or touch hot surfaces.
10. Do not place on or near a hot gas or electric burner, or in a heated oven.
11. Always attach plug to appliance first, then plug cord into wall outlet. To disconnect, turn any control to "off", then remove plug from wall outlet.
12. Do not use appliance for other than intended use.
13. **WARNING:** Do not remove the Cappuccinatore while in use, steam can be released.
14. Save these instructions.

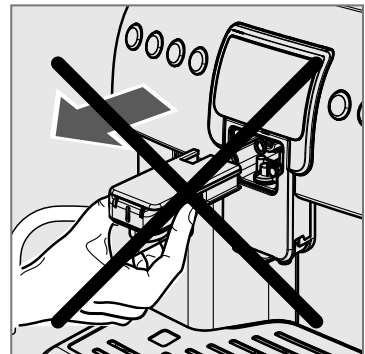

SAVE THESE INSTRUCTIONS

CAUTION

This appliance is for household use only. Any servicing, other than cleaning and user maintenance, should be performed by an authorized service center. Do not immerse machine in water. To reduce the risk of fire or electric shock, do not disassemble the machine. There are no parts inside the machine serviceable by the user. Repair should be done by authorized service personnel only.

1. Check voltage to be sure that the voltage indicated on the nameplate corresponds with your voltage.
2. Never use warm or hot water to fill the water tank. Use cold water only.
3. Keep your hands and the cord away from hot parts of the appliance during operation.
4. Never clean with scrubbing powders or harsh cleaners. Simply use a soft cloth dampened with water.
5. For optimal taste of your coffee, use purified or bottled water. Periodic descaling is still recommended every 2-3 months.
6. Do not use caramelized or flavored coffee beans.

INSTRUCTIONS FOR THE POWER SUPPLY CORD

- A. A short power-supply cord (or detachable power-supply cord) is to be provided to reduce risks resulting from becoming entangled in or tripping over a longer cord.
- B. Longer detachable power-supply cords or extension cords are available and may be used if care is exercised in their use.
- C. If a long detachable power-supply cord or extension cord is used,
 1. The marked electrical rating of the detachable power-supply cord or extension cord should be at least as great as the electrical rating of the appliance
 2. If the appliance is of the grounded type, the extension cord should be a grounding-type 3-wire cord, and
 3. The longer cord should be arranged so that it will not drape over the counter top or table top where it can be pulled on by children or tripped over.

Contents

Introduction	3
General Description (fig. 1)	3
Important	4
Intended Use.....	4
Power Supply - Power Cord.....	4
For the Safety of Others.....	4
Danger of Burns.....	4
Machine Location - Suitable Location for Operation and Maintenance.....	4
Storing the Machine - Cleaning.....	5
Malfunction.....	5
Fire Safety Precautions.....	5
First Use	6
Packaging.....	6
Preliminary Operations.....	6
Double Function Buttons.....	8
Setting the Language (Upon First Use).....	9
Warm-up and Rinsing.....	9
Rinse/Self-Cleaning Cycle.....	10
For a Perfect Espresso: Rinse the Coffee Circuit if Using the Machine for the First Time or After a Long Period of Inactivity.....	10
Measuring and Adjusting Water Hardness	12
"INTENZA+" Water Filter	14
Adjustments	16
Adjusting the Coffee Grinder.....	16
Adjusting the "Aroma" - Amount of Ground Coffee.....	16
Adjusting the Coffee Length.....	17
Adjusting the Cappuccino or Latte Macchiato Length.....	18
Eco-friendly: Stand-by.....	19
Brewing Coffee	19
Cup-warming Surface.....	19
Adjusting the Dispensing Spout.....	19
Using Coffee Beans.....	21
Using Pre-ground Coffee.....	21
Brewing Cappuccino	23
Latte Macchiato	24
Milk Handling	25
Milk Thermos (Optional).....	25
Milk Container.....	27
"SPECIAL" Products	28
Dispensing Hot Water.....	28
Long Coffee.....	29
Hot Milk.....	29
American Coffee.....	30
Steam.....	31
Beverage Programming	32
Dispensed Beverages Counters.....	32
Beverage Parameters.....	33
Hot Water Parameters (BEVERAGE MENU - >SPECIAL BEVERAGES).....	34
Activating Steam (BEVERAGE MENU -> SPECIAL BEVERAGES).....	34
Default Parameters.....	34

Machine Programming	35
General Menu	36
Display Menu	37
Water Menu	37
Maintenance	38
Factory Settings	38
Cleaning and Maintenance	39
General Cleaning.....	39
Cleaning the Cappuccinatore (After Each Use)	40
Day Cleaning - Thermos.....	43
Monthly Cleaning - Cappuccinatore + Thermos (Thorough Cleaning).....	45
Brew Group	48
Weekly Cleaning - Brew Group.....	48
Cleaning the Brew Group with the "Coffee Oil Remover" [®]	50
Brew Group Lubrication.....	51
Descaling.....	53
LCD Display Warnings	57
Troubleshooting	59
Technical Specifications	60
Service	62

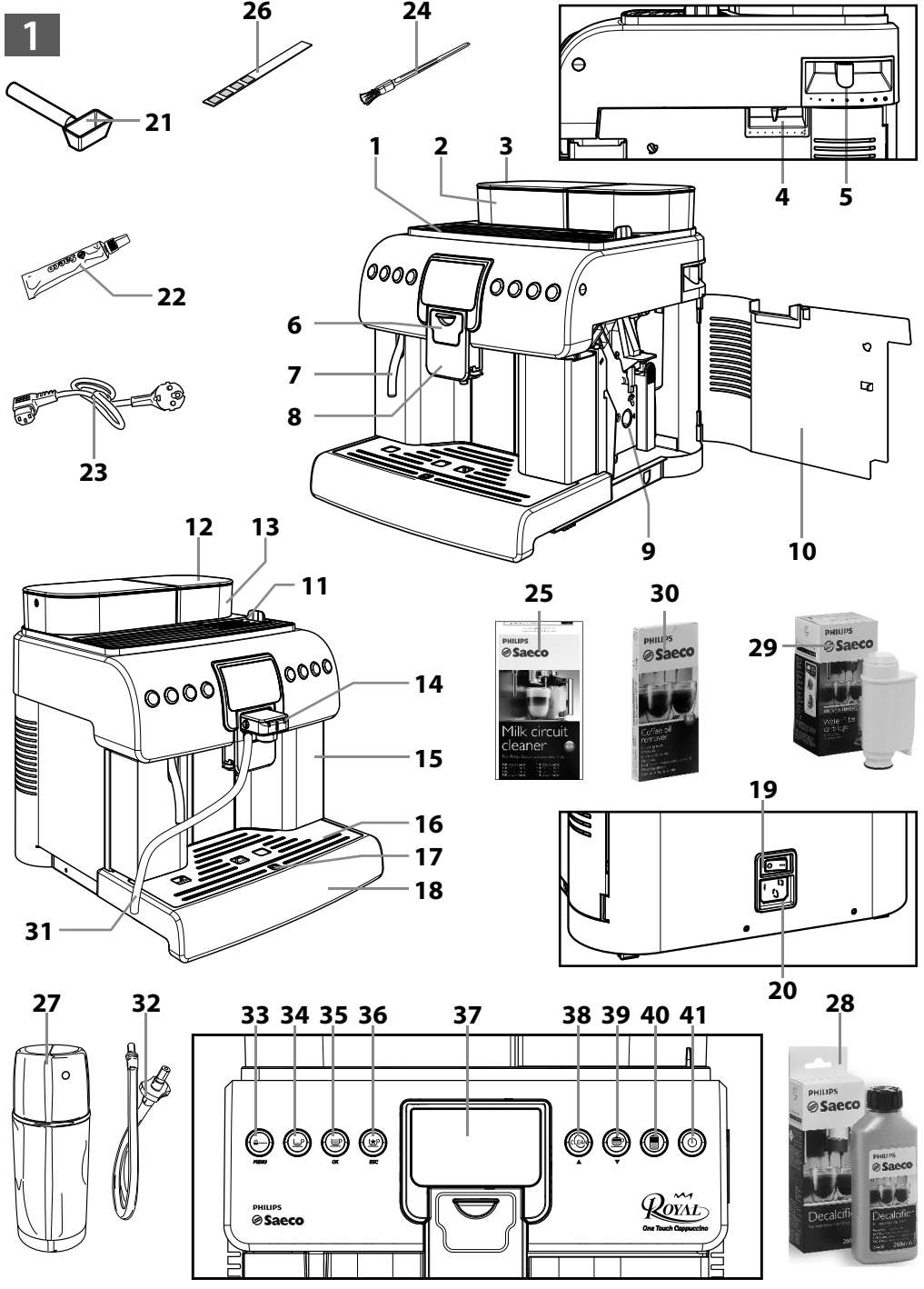

1

26

24

21

22

23

1

2

3

4

5

6

7

8

9

10

12

13

11

14

15

25



30



29



31

19

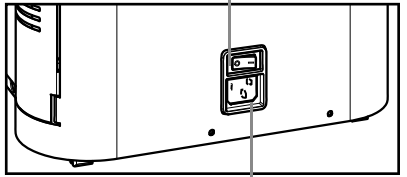

27

32

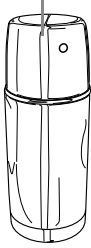

33

34

35

36

37

38

39

40

41

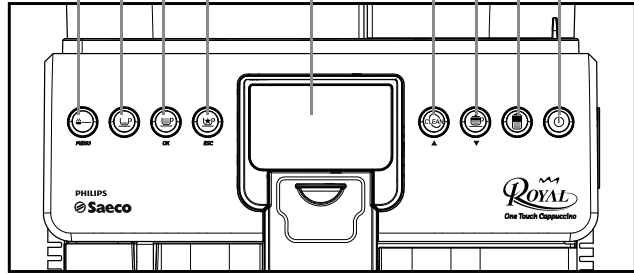

20

28



Introduction

Congratulations on your purchase and welcome to Philips Saeco!
To fully benefit from the support that Philips offers, register your product at www.philips.com/welcome.

In this user manual you will find all the information you need to install, use, clean and descale your appliance. In case you need further support, please contact the toll free Philips consumer care help line. You can find the phone number on the last page of this document and in the warranty booklet supplied with the appliance.

General Description (fig. 1)

- 1 Cup-warming surface
- 2 Water tank
- 3 Water tank lid
- 4 Coffee dose adjustment
- 5 Grinder adjustment
- 6 Cappuccinatore cover
- 7 Hot water wand
- 8 Dispensing spout
- 9 Brew group
- 10 Service door
- 11 Pre-ground coffee compartment + lid
- 12 Coffee bean hopper lid
- 13 Coffee bean hopper
- 14 Cappuccinatore (removable type)
- 15 Coffee grounds drawer
- 16 Cup holder grill
- 17 Full drip tray indicator
- 18 Drip tray + tray (inner) cover
- 19 Power button
- 20 Power cord socket
- 21 Pre-ground coffee dosing unit
- 22 Grease for brew group
- 23 Power cord
- 24 Cleaning brush
- 25 Milk circuit detergent - **(Optional)**
- 26 Water hardness test
- 27 Milk Thermos - **(Optional)**
- 28 Descaling solution - **(Optional)**
- 29 (INTENZA+) Filter - **(Optional)**
- 30 Brew group cleaning tablets - **(Optional)**
- 31 Suction tube for Cappuccinatore
- 32 Connection hose Thermos - Cappuccinatore - **(Optional)**
- 33 Pre-ground coffee selection button
2nd Function - "Menu" button to access the programming mode
- 34 Espresso coffee brew button
- 35 Coffee brew button
2nd Function - "OK" button to confirm selection
- 36 Special beverages selection button
2nd Function - "ESC" button to exit or stop the brewing procedure
- 37 Display
- 38 Cappuccinatore "Clean" button
2nd Function - "Page Up" button to scroll the menu
- 39 Cappuccino brew button
2nd Function - "Page Down" button to scroll the menu
- 40 Latte Macchiato brew button
- 41 ON/OFF button

Important

Read this user manual carefully before using the appliance and save it for future reference.

Never allow water to come into contact with any of the electrical parts of the machine: Danger of short circuit! Hot water may cause burning! Never not direct the hot water jet towards body parts. Handle the hot water wand with care.

Intended Use

The coffee machine is intended for domestic use only. Do not make any technical changes or use the machine for unauthorised purposes since this would create serious hazards! The appliance is not to be used by persons (including children) with reduced physical, mental or sensory abilities or with scarce experience and/or expertise, unless they are supervised by a person responsible for their safety, or they are instructed by this person on how to properly use the machine.

Power Supply - Power Cord

Connect the coffee machine only to a suitable socket.

The socket to which the machine is connected must be:

- Compatible with the type of plug installed on the machine.
- Suitably sized to comply with the data on the plate attached to the appliance;
- Connected to an efficient earthing system.

Never use the coffee machine if the power cord is defective or damaged. If the power cord is damaged, it must be replaced by the manufacturer or by its authorised service centre.

Do not pass the power cord around corners, over sharp edges or over hot objects and keep it away from oil.

Do not use the power cord to carry or pull the coffee machine.

Do not pull out the plug by the power cord or touch it with wet hands. Do not let the power cord hang freely from tables or shelves.

For the Safety of Others

Prevent children from playing with the machine. Children are not aware of the risks related to electrical household appliances. Do not leave the machine packaging materials within the reach of children.

Danger of Burns

Never direct the jet of hot steam and/or hot water towards yourself or others: **Danger of burns!**

Machine Location - Suitable Location for Operation and Maintenance

For best use, it is recommended to:

- Choose a safe, level surface, where there will be no danger of overturning the appliance or being injured.
- Choose a location that is sufficiently well-lit, clean and near an easily

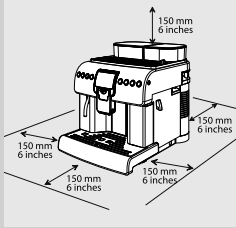

reachable socket.

- Provide for a minimum distance from the sides of the machine as shown in the illustration.
- While switching on or off the machine, we suggest placing an empty glass under the dispensing spout.

Do not keep the machine at temperatures below 0°C. Frost may damage the machine. Do not use the coffee machine outdoors.

In order to prevent its housing from melting or being damaged, do not place the machine on very hot surfaces and close to open flames.

Storing the Machine - Cleaning

Before cleaning the machine, turn it off by pressing the "⏻" button and then by switching the power button to "0". Finally, remove the plug from the socket.

Keep the machine at its best, clean and store it properly.

Since the machine uses natural ingredients to brew beverages (coffee beans, water, milk, etc.), some residues of ground coffee or condensed water could be present on its supporting surface. For this reason we recommend to periodically clean both the visible parts of the machine and the area beneath it.

Before storing the machine we strongly recommend to clean it:

- Water left in the tank and/or the water circuit for several days should not be consumed. If the machine is going to remain inactive for a long time, dispense water from the hot water wand and carefully clean the Cappuccinatore (if supplied).
- Turn off the power button and clean the machine. Finally, remove the plug from the socket. Wait for the machine to cool down.

Never immerse the machine in water! Store it in a dry place, out of the reach of children. Keep it protected from dust and dirt.

It is strictly forbidden to tamper with the internal parts of the machine. For thorough cleaning, the Cappuccinatore can be detached and disassembled and its parts can be put in a dishwasher (not professional type). The washing process in the dishwasher may cause the surface of the Cappuccinatore parts to tarnish or the graphics to fade, especially if aggressive detergents are used.

This is a normal phenomenon and does not affect in any way the correct operation of the milk system.

Malfunction

In case of failure, problems or a suspected fault resulting from the falling of the machine, immediately remove the plug from the socket. Never attempt to operate a faulty machine.

For further information on troubleshooting and service, please refer to the "Troubleshooting" and "Service" chapters.

Fire Safety Precautions

In case of fire, use carbon dioxide (CO₂) extinguishers. Do not use water or dry powder extinguishers.

First Use

Packaging

The original packaging has been designed and constructed to protect the machine during transport. We recommend keeping the packaging material for possible future transport.

Preliminary Operations

Remove the drip tray with grill and the coffee machine from the packaging. Place the machine in a place that meets the requirements described in the safety regulations.

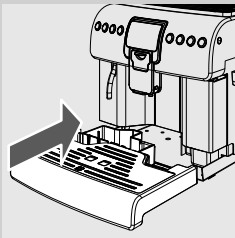

- 1 Place the drip tray with grill into its seat on the machine. Make sure the tray is fully inserted to its limit stop.

Note: Insert the plug into the socket only when indicated and make sure the power button is on "0".

Important Note: Carefully read the explanations of all the warnings the machine displays to the user on the control panel LCD display (section "LCD Display Warnings").

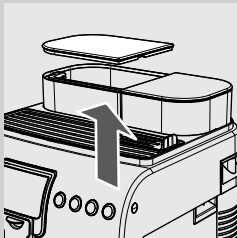

- 2 Remove the lid from the water tank.

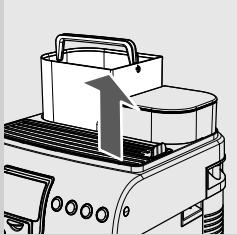

- 3 Remove the water tank from its seat by only using the relevant handle.

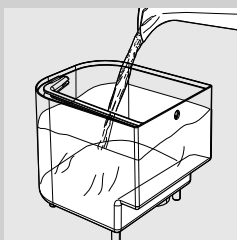

- 4 Rinse and fill it with fresh water, making sure that the (MAX) level indicated in the tank is not exceeded. Place the water tank back into its seat and reposition the lid.

Fill the tank only with fresh, non-sparkling water. Hot water or any other liquid may damage the tank and/or the machine. Do not operate the machine without water. Make sure there is enough water in the tank.

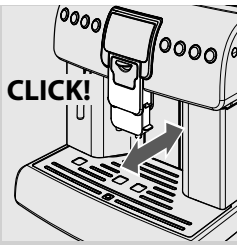

- 5** Make sure the dispensing spout is in correct position. Move it horizontally until you hear the CLICK indicating the correct position. If this is not done, some product might leak out of the dispensing spout.



- 6** Remove the coffee bean hopper lid.

Note: The hopper may be provided with different safety features according to the regulations applicable in the country of use of the machine.

- 7** Slowly pour the coffee beans into the hopper.

If the water tank is not inserted, check that no coffee beans fall into the tank compartment. If this happens, remove them to avoid any malfunctions.

Only coffee beans must be put into the coffee bean hopper. Ground coffee, instant coffee or any other object may damage the machine.

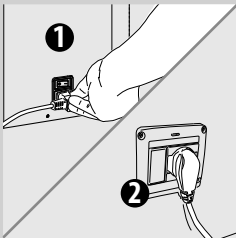

- 8** Reposition the coffee bean hopper lid.

- 9** Insert the plug into the socket on the back of the machine.

- 10** Insert the plug of the other end of the cable into a wall socket with suitable power voltage.

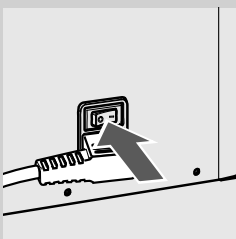

- 11** Switch the power button to "I" to turn on the machine.

Note: The power button is located in the rear part of the machine.

After carrying out a check cycle, the machine goes into stand-by mode and the "⏻" button blinks.

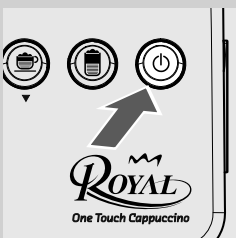

- 12** To turn on the machine simply press the "⏻" button.

Note: The language needs to be selected only upon first use (see page 9).

Note: Once the warm-up is complete, upon first use the machine primes the circuit and performs a rinse cycle of the internal circuits. A small amount of water is dispensed. Wait for this cycle to be completed.

Double Function Buttons

Some buttons in the control panel have a double function. The double function is only activated in certain moments during the machine operation or when accessing the programming mode.

The additional function is indicated by the icon under the machine button.



Pre-ground coffee selection - MENU Button

This button allows you to select the coffee brew mode with pre-ground coffee.

2nd Function - Hold it pressed for 5 seconds to access the machine programming menu.



Coffee Brew - OK Button

This button allows you to select one coffee brewing.

2nd Function - Press it to select the displayed option.



Special Beverages Selection - ESC Button

This button allows you to access the list of special beverages that the machine can brew.

2nd Function - Press it to exit the selected page and/or the programming mode completely and/or to stop brewing the beverage.

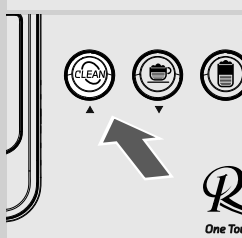

CLEAN - "▲" Button

This button allows you to perform a cleaning cycle of the Cappuccinatore by dispensing steam (see the special section for further details).

2nd Function - Press it to scroll the current page selection up.

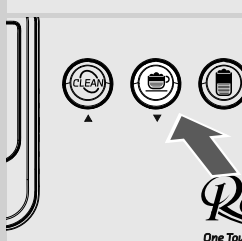

Cappuccino Brew - "▼" Button

This button allows you to select the cappuccino brewing.

2nd Function - Press it to scroll the current page selection down.

Setting the Language (Upon First Use)

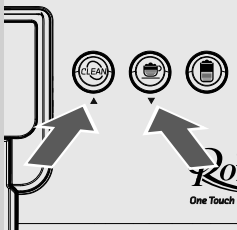
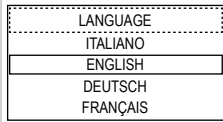

At first start-up, the machine requires you to select and store the desired language for the displayed messages. This allows you to adjust the parameters of the beverages to the typical parameters of the country where the machine is used. This is why some languages are differentiated also by country.

If no language is selected, you will be requested to select it at next machine start-up.

- 1 Select the language by pressing the "CLEAN" or "CUP" button.
- 2 Press the "CUP" button to store the language.

Warm-up and Rinsing

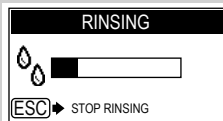
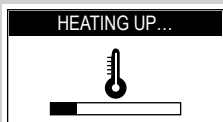

- 1 Upon start-up, the machine activates the warm-up phase. Wait until it is completed.

Note: The bar is in progress to show that the machine is heating up the system.

- 2 Once the warm-up is complete, the machine performs a rinse cycle of the internal circuits.

Note: The bar is in progress to show that the machine is performing the system rinse cycle.

A small quantity of water is dispensed. Wait for the cycle to end.

Note: The cycle can be stopped by pressing the "CUP" button.

- 3 Then, the machine is ready for use.

The logo **ROYAL** is displayed indicating that the machine is ready for use.

Note: If the machine is being used for the first time or after a long period of inactivity, follow the procedures described in the following section.

Rinse/Self-Cleaning Cycle

This cycle allows you to rinse the internal coffee circuits with fresh water. The cycle is carried out:

- At machine start-up (with cold boiler)
- After priming the circuit (with cold boiler)
- During the stand-by preparation phase (if at least a coffee product has been brewed)
- During the turning off phase after pressing the "⏻" button (if at least a coffee product has been brewed).

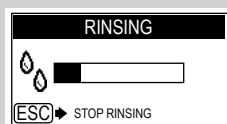

A small amount of water will be dispensed to rinse and heat all the machine parts; in this phase this icon is displayed.

Wait for the cycle to finish automatically. You can stop dispensing by pressing the "ESC" button.

For a Perfect Espresso: Rinse the Coffee Circuit if Using the Machine for the First Time or After a Long Period of Inactivity.

These simple operations will make it possible to always brew excellent coffee. They have to be performed:

- A) At first start-up.
- B) When the machine remains inactive for a long time (more than 2 weeks).



1 Place a large container under the dispensing spout.

2 Empty the water tank, wash and rinse it and fill it with fresh water.



3 Select the pre-ground coffee brewing function by pressing the "PRE" button once.



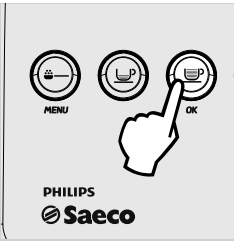

The display indicates that the pre-ground function has been selected.



INSERT
GROUND COFFEE
AND PRESS OK
ESC → ESC



SPECIAL BEVERAGES
HOT WATER
LONG COFFEE
HOT MILK
AMERICAN COFFEE

HOT WATER
 
ESC → STOP HOT WATER



4 Press the "☕" button to select coffee.

Note: Do not add pre-ground coffee into the compartment.

5 Press the "☕" button to start the dispensing procedure.

The machine will dispense hot water through the dispensing spout. Wait until the dispensing procedure is complete and empty the water tank.

6 Repeat the operations from step 1 to step 5 for 3 times, then continue with step 7.

7 Place a container under the hot water wand.

8 Press the "☕" and the "☕" buttons to select and start dispensing HOT WATER.

9 When the hot water dispensing procedure is complete, empty the container.

10 The machine is now ready for use.

Measuring and Adjusting Water Hardness

Measuring water hardness is very important in order to correctly manage the "INTENZA+" filter and the frequency with which the machine must be descaled.

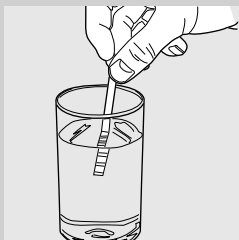

- 1 Immerse the water hardness test strip - provided with the machine - in water for 1 second.

Note: The test strip is only valid for one measurement.

- 2 Check how many squares change colour and refer to the table.

Note: The letters correspond to the references that are located in the base of the Intenza filter. The filter must be adjusted according to this measurement.

- 3 The numbers correspond to the settings indicated in the following machine adjustments.

More precisely:

- 1 = (very soft water)
- 2 = (soft water)
- 3 = (hard water)
- 4 = (very hard water)

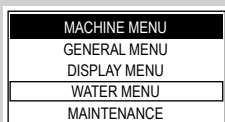
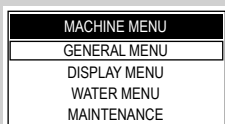
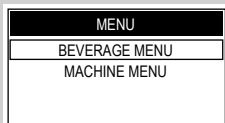
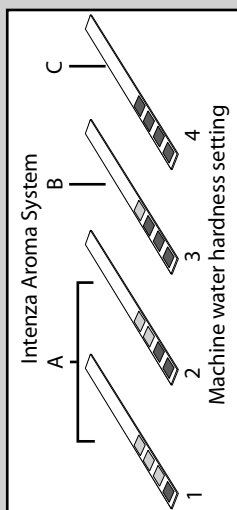

- 4 Hold the "MENU" button pressed for 5 seconds to access the programming mode.

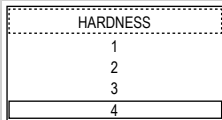
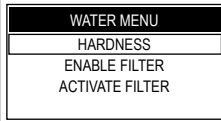

- 5 To select the "MACHINE MENU" option, press the "MACHINE MENU" button.
Press the "MACHINE MENU" button for access.

- 6 Press the "WATER MENU" button until the "WATER MENU" option can be selected.
Press the "WATER MENU" button for access.



- 7** Press the " " button to enter the "HARDNESS" menu.

Note: The machine is supplied with a standard adjustment suitable for most of the uses.

- 8** Press:
- The " " button to increase the value
- or
- the " " button to reduce the value.

- 9** Press the " " button to confirm the selected change.

- 10** Press the " " button until the following product brewing page is displayed.

"INTENZA+" Water Filter

The "INTENZA+" water filter can improve the quality of water. Using the "INTENZA+" filter will prevent limescale from building up and will ensure a much more intense aroma to your espresso coffee. We therefore recommend you to install the "INTENZA+" water filter. You can purchase it at your local dealer, on-line at the Philips on-line shop at <http://shop.philips.com> or at the authorised service centres.

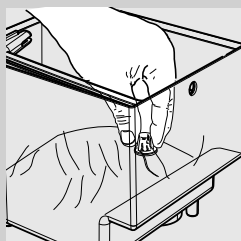

- 1** Remove the small white filter from the tank and store it in a dry place sheltered from dust.

Measuring water hardness is very important in order to correctly manage the "INTENZA+" water filter and the frequency with which the machine must be descaled.

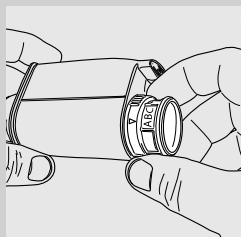

- 2** Remove the "INTENZA+" water filter from its package. The filter should be set according to the measurements performed to set water hardness. Use the water hardness test strip provided with the machine. Set the "Intenza Aroma System" as specified on the filter package (see section "Measuring and Adjusting Water Hardness").

A = Soft water
B = Hard water (standard)
C = Very hard water



- 3** Immerse the "INTENZA+" water filter vertically (with the opening positioned upwards) in cold water and delicately press its sides so as to let the air bubbles out.

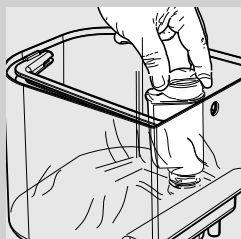

- 4** Put the filter into the empty tank. Press it until its limit stop.
- 5** Fill the tank with fresh drinking water and reinsert it into the machine.

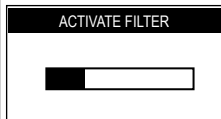
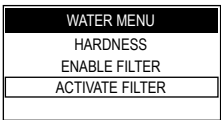
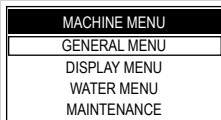
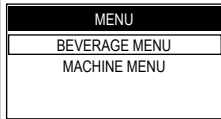

6 Place a large container under the hot water wand.

7 Hold the "MENU" button pressed for 5 seconds to access the programming mode.

8 To select the "MACHINE MENU" option, press the "MACHINE MENU" button.
Press the "OK" button for access.

9 Press the "MACHINE MENU" button until the "WATER MENU" option can be selected.
Press the "OK" button for access.

10 Press the "MACHINE MENU" button until the "ACTIVATE FILTER" option can be selected.
Press the "OK" button for access.

11 Press the "MACHINE MENU" button.

Note: To quit the procedure press the "ESC" button until the ROYAL logo is displayed.

12 Press the "MACHINE MENU" button to confirm the introduction of the new filter.

13 Press the "MACHINE MENU" button to confirm.

Wait until the machine stops dispensing the necessary water to activate the filter.

At the end of the cycle, remove the container that you had previously placed under the hot water wand.

Note: At the end of the procedure, the display automatically returns to the product brewing page. If the water filter is not available, insert the small white filter previously removed (see step 1) into the tank.

Adjustments

The machine that you have bought allows for certain adjustments that will permit you to use it to its full potential.

Adjusting the Coffee Grinder

Warning! The grind adjustment lever must only be turned when the coffee grinder is working. Do not pour ground and/or instant coffee into the coffee bean hopper.

Do not insert any material other than coffee beans into the hopper. The grinder contains moving parts that may be dangerous. Therefore, do not insert fingers and/or other objects. Turn off the machine by pressing the ON/OFF button and remove the plug from the socket before carrying out any type of operation inside the coffee bean hopper.

The machine allows you to make slight adjustments to the coffee grinder to adapt it to the kind of coffee used.

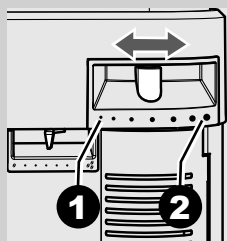

To make any adjustment, use the lever located on the side of the machine. Turn the lever one notch at a time and brew 2-3 cups of coffee; this is the only way to notice differences in grind.

The reference marks indicate the grind setting. You can set different degrees of grind with the following references:

- 1 - Fine Grind
- 2 - Coarse Grind

Adjusting the "Aroma" - Amount of Ground Coffee

The machine allows you to program the amount of coffee to be ground for preparing each cup of coffee.

Warning! The Aroma adjustment lever must only be turned when the coffee grinder is stopped. Adjustment must be performed before brewing coffee.

To make any adjustment, use the lever located on the side of the machine.

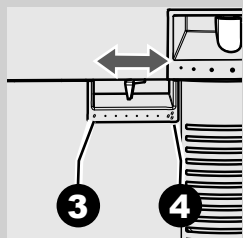

The reference marks indicate the amount of ground coffee which has been set. You can set different amounts with the following references:

- 3 - Minimum coffee amount (about 7 grams)
- 4 - Maximum coffee amount (about 11 grams)

Adjusting the Coffee Length

The machine allows you to adjust the amount of brewed coffee according to your taste and/or the size of your cups.

Note: This function cannot be used to adjust American coffee length, this product requires using the specific menu in the "BEVERAGE MENU".

Each time the "☺" or "☺_{OK}" button is pressed and released, the machine brews a pre-set amount of coffee. This amount may be reprogrammed according to your taste. Each button may be individually programmed for a specific brew setting.

Note: As an example, the following procedure describes the programming of the "☺" button, which is usually associated with espresso coffee.

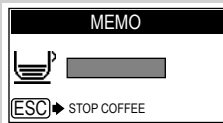
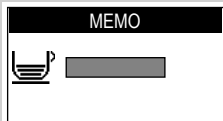

- 1 Place a cup under the dispensing spout.

- 2 Press and hold the "☺" button until the "MEMO" message is displayed **and remove your finger**. The machine is now programming.

The machine begins the brewing phase. The "STOP COFFEE" message is displayed.

- 3 From now on, press the "☺_{ESC}" button when the desired amount of coffee is reached in the cup.

Now the "☺" button has been programmed; each time it is pressed and released, the machine will brew the same amount that has just been set.

Adjusting the Cappuccino or Latte Macchiato Length

The machine allows you to adjust the brewed amount of Cappuccino (or Latte Macchiato) according to your taste and/or the size of your cups.

Each time the "☕" or "☕" button is pressed and released, the machine brews a pre-set amount of Cappuccino (or Latte macchiato). This amount may be reprogrammed according to your taste. Each button may be individually programmed for a specific brew setting.

Note: Before programming, you need to prepare the machine and milk as described in the Cappuccino section.

Note: As an example, the following procedure describes the programming of the "☕" button, which is normally associated with cappuccino.



- 1 Place a cup or a mug under the dispensing spout.

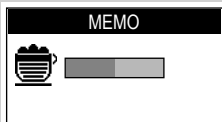

- 2 Press and hold the "☕" button until the "MEMO" message is displayed **and remove your finger**. The machine is now programming.

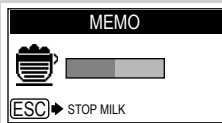

The machine begins the milk dispensing phase. The "STOP MILK" message is displayed.

- 3 From now on, press the "☕" button when the desired amount of milk is reached in the cup.

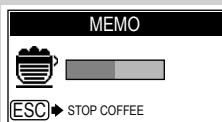

- 4 Immediately after, the machine begins the coffee brewing phase. The "STOP COFFEE" message is displayed.

- 5 From now on, press the "☕" button when the desired amount of coffee is reached in the cup.

Now the "☕" button has been programmed; each time it is pressed and released, the machine will brew the same amount that has just been set.

Eco-friendly: Stand-by

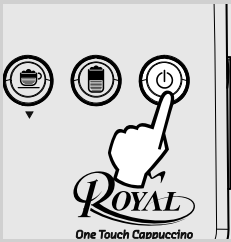

The machine is designed for energy saving. The machine automatically turns off after 30 minutes of inactivity.

Note:

- During the turning off phase, the machine performs a rinse cycle, if a coffee product has been brewed.
- Time can be programmed according to your needs (see page 36).

To turn on the machine again, simply press the "⏻" button (if the power button is set to "I"). In this case the machine will perform the rinse cycle only if the boiler is cold.

Brewing Coffee

Before brewing coffee check the lights on the display and make sure the water tank and coffee bean hopper are full.

Before brewing coffee, adjust the height of the dispensing spout according to your needs and select the aroma by using the adjustment lever; otherwise, select the pre-ground coffee.

Cup-warming Surface

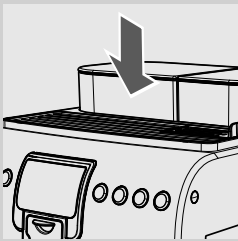

The machine features a cup-warming surface to keep your cups warm and ready. Warm cups bring out the full aroma of coffee and let you enjoy its taste in full.

Place the cups that you usually use and wait until they are warm.

Note: The cup-warming surface has a higher temperature than the other machine surfaces, so we recommend not to touch it with sensitive body parts to avoid irritations.

Using the cup-warming surface for other purposes is prohibited.

The cup-warming surface is disabled by default for energy saving purposes. Refer to page 36 of the manual to activate it.

Adjusting the Dispensing Spout

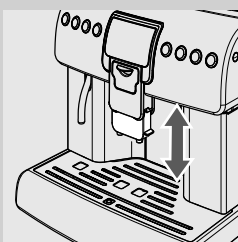

Most cups on the market can be used with this coffee machine. The height of the dispensing spout may be adjusted to better fit the dimensions of the cups that you wish to use.

Manually move the dispensing spout up or down to adjust its height.



The recommended positions are:
For the use of small cups.



For the use of large cups.



Two cups can be placed under the dispensing spout to brew two cups of coffee at the same time.

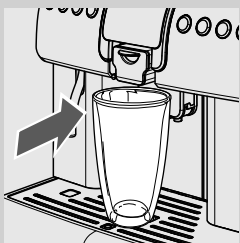

If you want to use tall glasses or mugs, push the dispensing spout to its limit stop. In this case, you can just brew one product at a time.



Note: Before any brewing procedure and/or when bringing the dispensing spout back to its normal brewing position, make sure that it is correctly positioned. This can be noted through the CLICK indicating the correct position. If this is not done, some product might leak out of the dispensing spout.

Using Coffee Beans

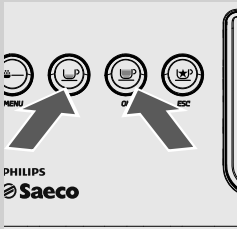

To brew coffee, press and release:

- 1 The "☕" button for a cup of espresso.
or
the "☕" button for a cup of long espresso.

The brewing cycle then starts:

To brew 1 cup of coffee, press the desired button once.

To brew 2 cups of coffee, press the desired button twice consecutively.

Note: To brew 2 cups of coffee, the machine automatically grinds and doses the correct amount of coffee. Brewing two coffees requires two grinding cycles and two brewing cycles, which the machine carries out automatically.

- 2 Once the prebrewing cycle is complete, coffee begins to come out of the dispensing spout.
- 3 Coffee brewing stops automatically when the set level is reached. However, it is possible to stop the coffee brewing by pressing the "☕" button.

Note: The machine is adjusted to brew a true Italian espresso coffee. This feature may slightly lengthen the brewing time, allowing the intense coffee flavour to develop fully.

Using Pre-ground Coffee

This function allows using pre-ground coffee.

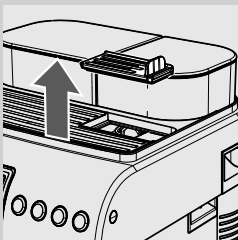

Pre-ground coffee must be poured into the relevant compartment positioned next to the coffee bean hopper. Only use ground coffee for espresso machines and never coffee beans or instant coffee.

Note:

If no pre-ground coffee is poured into the compartment, only water will be dispensed.

If the dose is excessive and 2 or more measuring scoops of coffee are used, the machine will not brew the product. Also in this case, the machine will run an empty cycle and discharge any ground coffee into the coffee grounds drawer.

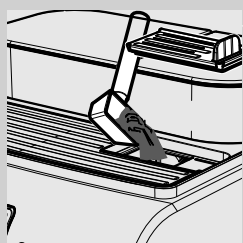
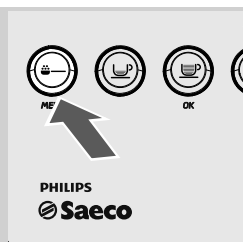

To brew coffee:

- 1 Press and release the "PRE" button to select and activate the pre-ground coffee function.

This page indicates that the function has been activated.

Note: If the brewing is not started within 10 seconds, the machine goes back to the coffee beans operating mode and displays the  symbol.

- 2 Press and release:
The "ESP" button for a cup of espresso
or
the "OK" button for a cup of long espresso.

Note: If the brewing is not started within 30 seconds after the page is displayed or in case the "ESC" button is pressed, the machine returns to the main menu and discharges any inserted coffee into the coffee grounds drawer.

- 3 Lift the pre-ground coffee compartment lid.

Warning: Add only pre-ground coffee to the compartment. Other substances and objects may cause severe damages to the machine. Such damages will not be covered by warranty.

Add only 1 scoop of pre-ground coffee to the compartment. Use only the measuring scoop supplied with the machine to perform this operation. Then, close the lid.

- 4 Press the "OK" button. The brewing cycle starts. Once the prebrewing cycle is complete, coffee begins to come out of the dispensing spout.
- 5 Coffee brewing stops automatically when the set level is reached. However, it is possible to stop the coffee brewing by pressing the "ESC" button. After brewing the product, the coffee beans configuration of the machine is restored.

Note: Repeat the steps described above to brew more cups of coffee.

Brewing Cappuccino

The machine allows brewing cappuccino quickly and easily with the touch of a button.

Danger of burning! Dispensing may be preceded by small jets of hot water.

Important Note: Immediately after using the Cappuccinatore to froth milk, clean the suction hose externally with a damp cloth. This way, all parts will be perfectly clean and free of any milk residue.

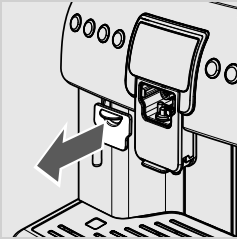

- 1 Remove the cover from the front side.

Note: The cover can be placed on the machine side using the integrated magnet.

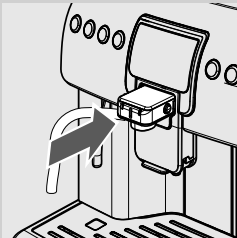

- 2 Insert the Cappuccinatore into its seat until it locks into place. Check that it cannot slide away.

Warning: Before using the Cappuccinatore, clean it along with the Thermos (if used), as described in the "Cleaning and Maintenance" section.

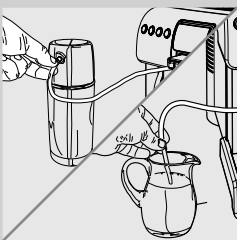

- 3 Insert the clean hose (according to your choice)
 - in the milk Thermos
 - or
 - directly in the milk container.

Note: To ensure better results when preparing a cappuccino, use cold milk.



- 4 Place the cup under the dispensing spout. Press the "☺" button.



5 The machine needs a preheating time.

6 After preheating, the machine starts brewing the cappuccino.

7 At this stage, the machine dispenses frothed milk. You can stop dispensing by pressing the "☺" button.

8 After dispensing milk, the machine brews coffee. You can stop brewing by pressing the "☺" button.

You can enjoy your cappuccino just like at the coffee bar.

After using the Cappuccinatore, clean it as described in the "Cleaning the Cappuccinatore" section.

Remove the container or Thermos and clean it, if necessary.

Note: The "WARNING CLEANING" function can be activated, if desired; this function reminds you when the Cappuccinatore needs to be cleaned. To activate this function, refer to the machine programming section on page 38.

Latte Macchiato

The machine allows brewing a latte macchiato quickly and easily with the touch of a button.

To brew a latte macchiato perform all steps for preparing a cappuccino up to step 4.

We recommend using tall glasses for this type of preparation, thus properly moving the dispensing spout.

When the machine is ready, press the "☺" button to start brewing the latte macchiato.

The machine prepares the latte macchiato automatically.

After using the Cappuccinatore, clean it as described in the "Cleaning the Cappuccinatore" section (See page 40).

Remove the container or Thermos and clean it, if necessary.

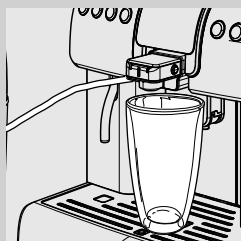

Milk Handling

With this machine you can prepare cappuccino, latte macchiato and other milk-based beverage quickly and enjoy your relax time.

You can use either the supplied Thermos or directly the milk container which can be purchase ad your local dealer's shop.

MILK MUST BE USED AND STORED IN ACCORDANCE WITH THE INSTRUCTIONS GIVEN ON THE MANUFACTURER'S ORIGINAL PACKAGING. WE ACCEPT NO LIABILITY FOR USE OF MILK UNSUITABLE FOR HUMAN CONSUMPTION.

Milk-based beverages can only be prepared if the Cappuccinatore is installed.

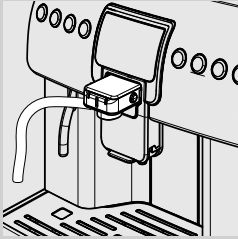

Milk Thermos (Optional)

The machine is supplied with a Thermos specifically designed and built to improve milk storage, since it limits the milk temperature increase. The Thermos is only suitable for quick and easy domestic use. It is not recommended for continuous, professional-type operation.

Do not use the Thermos to store milk in the refrigerator. Its insulating power does not allow the refrigerator to cool milk and to reach the correct storage temperature. It is recommended to pour in a jug the milk remained in the Thermos and that has not been used. Then store it in the refrigerator for correct storage.

To increase storage performance, we recommend filling with cold milk (approx. 4°C).

Note: Before using the Thermos, make sure it is thoroughly clean and sanitary. If there is milk left in the Thermos, make sure it is still suitable for food consumption before using it.

Do not use the Thermos to heat any beverage other than milk.

The container must be removed at least once a month to allow proper cleaning of all parts. In this way, you can keep a high sanitation level of the brewed beverages. For correct cleaning, refer to the "CLEANING THE THERMOS" section (see pages 43-45).

Warning: Before using the Thermos, clean it as described in the "Cleaning and Maintenance" section (See page 39).

For correct storage, milk needs to be kept at low temperatures. The Thermos allows you to keep milk out of the fridge as long as it is necessary for its correct use.

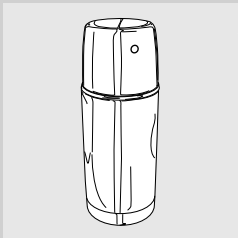

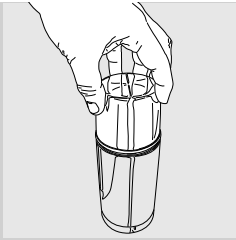

At an ambient temperature of 20°C, the temperature of the milk in the Thermos increases by 4-6°C after 4 hours. Consider this approximate data to determine if milk can still be used in relation to the time it has been stored in the Thermos.

- 1 Loosen and remove the Thermos lid.



- 2 Pour milk into the Thermos. Fill in with milk from the MIN level indicator and do not exceed the MAX level indicator.

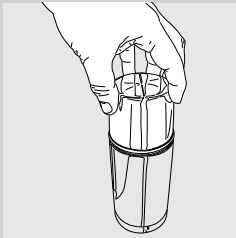

- 3 Reinsert the Thermos lid by screwing it.

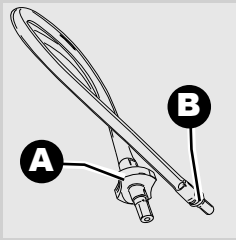

- 4 Use only the supplied hose to connect the Thermos to the Cappuccinatore.

This hose features two special fittings for optimum operation. The fittings are different from each other, i.e. fitting (B) is to be connected to the Cappuccinatore, while fitting (A) is to be properly connected to the Thermos.

Note: The fittings cannot be exchanged, as this could cause the system to malfunction.

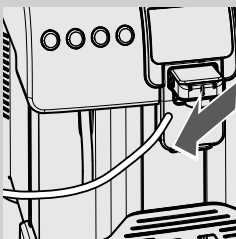

- 5 Remove the suction tube that is installed in the Cappuccinatore.

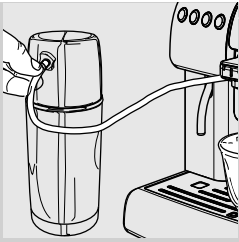

6 Insert the hose fitting in the Thermos.

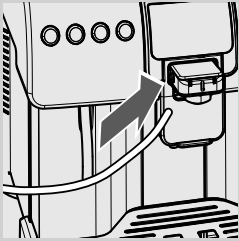

7 Insert the fitting in the Cappuccinatore.

The Thermos can now be used to brew milk-based products.

Milk Container

The milk container can be used directly with the machine to prepare the beverages.

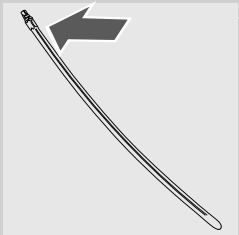

1 For direct use of the milk container it is necessary to use the Cappuccinatore suction tube. This tube only features one fitting.

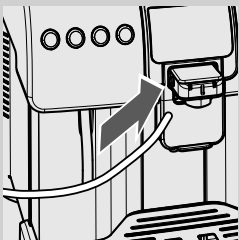

2 Check that the tube is inserted in the Cappuccinatore.

Warning: In this case, make sure that the tube is clean on the outside as well, to prevent milk from coming into contact with the dirt on the outside of the tube.

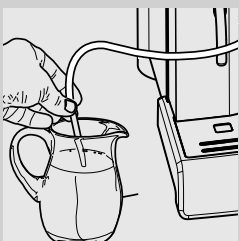

3 Remove the clean suction tube and insert it directly into the container.

Note: After use, remove the tube and wash it properly. Place the container back in the fridge for correct milk storage.

"SPECIAL" Products

The machine is designed to brew other products not displayed on the control panel.

Note: After pressing the "☺" button, if no product is selected, the machine goes back to the main menu after 10 seconds.

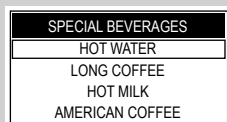
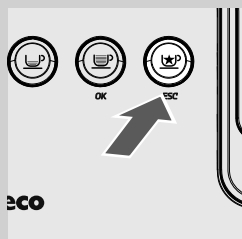

- 1 Press the "☺" button to enter the menu.
- 2 The display shows the page for "special" beverages.
- 3 Select the desired beverage by pressing the "CLEAN" or "☺" button.
- 4 When the desired beverage has been selected, press the "☺" button to start the preparation.

Refer to the relevant section about brewing the desired beverage.

Note: If no selection is carried out within 10 seconds, the machine goes back to the home page.

In order to prepare milk-based beverages, install the Cappuccinatore and the Thermos (if necessary) after washing them as described in the "Cleaning and Maintenance" section.

Dispensing Hot Water

Dispensing may be preceded by short spurts of hot water. Risk of burning. The hot water wand may reach high temperatures.

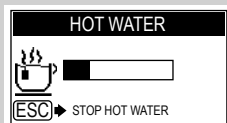
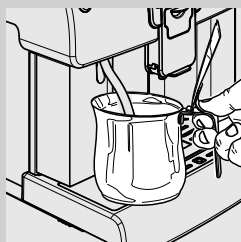
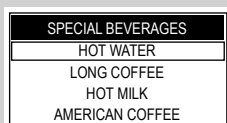

- 1 Press the "☺" button to enter the menu.
- 2 Place a container under the hot water wand.
- 3 Press the "☺" button to start the preparation.
- 4 After dispensing, remove the container with hot water.

Note: You can stop dispensing by pressing the "☺" button.

Long Coffee

This programme allows you to prepare a long coffee.

Note: In this case, you can just prepare one coffee at a time.



- 1 Press the "☕" button to enter the menu.
- 2 Press the "☕" button to select "LONG COFFEE".
- 3 Place a suitable cup under the dispensing spout.
- 4 Press the "☕" button to start the preparation.
- 5 After brewing, remove the coffee cup.

Hot Milk

This programme allows you to prepare a hot milk.

Danger of burning! Dispensing may be preceded by small jets of hot water.

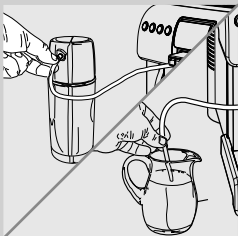
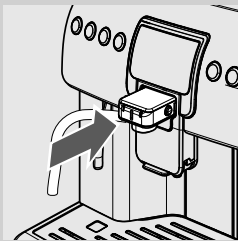

- 1 Remove the cover from the front side.
- 2 Insert the complete Cappuccinatore into its seat until it locks into place. Check that it cannot slide away.
- 3 Insert the clean hose (according to your choice)
 - in the milk Thermos
 - or
 - directly in the milk container.

Note: To ensure better results, use cold milk.



- 4 Press the "☺" button to enter the menu.
- 5 Press the "☺" button to select "HOT MILK".
- 6 Place a suitable cup under the dispensing spout.
- 7 Confirm by pressing the "OK" button to start the preparation.

Note: You can stop dispensing by pressing the "☺" button.

- 8 After dispensing, remove the cup with milk.

After using the Cappuccinatore, clean it as described in the "Cleaning the Cappuccinatore" section (See page 40).

Remove the container or Thermos and clean it, if necessary.

American Coffee

This programme allows preparing and American coffee.

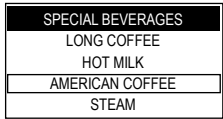

- 1 Press the "☺" button to enter the menu.
- 2 Press the "☺" button to select "AMERICAN COFFEE".
- 3 Place a suitable cup under the dispensing spout.
- 4 Press the "OK" button to start the preparation.
- 5 After brewing, remove the coffee cup.

Steam

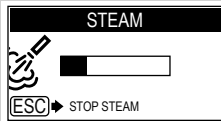
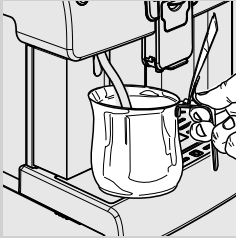
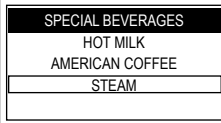





Note: By default, this function is disabled and not visible. It can become visible and available only if it is activated manually in the beverage programming:

BEVERAGE MENU -> SPECIAL BEVERAGES -> STEAM -> ON

Dispensing may be preceded by short spurts of hot water. Danger of burns. The steam wand may reach high temperatures.

This program allows steam to be dispensed in order to heat up the beverages directly in the container.

Note: Clean the wand before using it to heat any liquid.

- 1 Press the “” button to access the menu.
- 2 Press the “” button to select “STEAM”.
- 3 Place a suitable cup under the hot water wand and immerse the wand in the liquid to heat.
- 4 Press the “” button to start the preparation.
- 5 To stop the dispensing press the “” button.

Beverage Programming

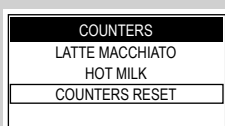
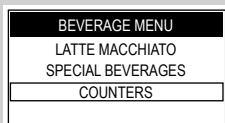
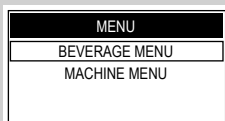

All beverage settings can be customized.

- 1 Press and hold the "MENU" button for 5 seconds to access the machine main menu.

When you enter the programming mode, the buttons have a different function:

"OK" button = "OK" (confirms a selection or a change you have made)

"CLEAN" button = "▲" (scrolls up the menu)

"MENU" button = "▼" (scrolls down the menu)

"ESC" button = "ESC" (confirms when you exit a selection)

- 2 Press the "OK" button to confirm the selection and enter the "BEVERAGE MENU".

This function allows you to set all parameters concerning a beverage brewing.

Dispensed Beverages Counters

This menu enables checking how many products have been brewed. Press the "MENU" button until the "COUNTERS" option is selected.

Press the "OK" button to enter the option and display the number of brewing procedures performed for each product.

This section, which is displayed as the last option in the "COUNTERS" menu, allows you to reset all the counters of the products that have been dispensed until that moment. This can be useful to reset the machine after maintenance.

Beverage Parameters

BEVERAGE MENU
ESPRESSO
COFFEE
CAPPUCCINO
LATTE MACCHIATO

CAPPUCCINO
PREBREWING
COFFEE TEMPERATURE
COFFEE LENGTH
MILK QUANTITY



PREBREWING

COFFEE TEMPERATURE

COFFEE LENGTH

MILK QUANTITY

In this case we look at how to programme a customized cappuccino. The milk managing options are not shown when a coffee brewing (espresso or long coffee) is being programmed.

Press the  button to select the "CAPPUCCINO" and the  button to enter the menu.

The following describes the different functions.

Prebrewing: Coffee is slightly dampened before brewing so as to bring out its full aroma and let it acquire an excellent taste.

OFF: prebrewing is not performed.

LOW: activated.

HIGH: longer in order to bring out the coffee taste.

This section allows you to program the temperature for coffee brewing.

LOW: low temperature.

NORMAL: standard temperature.

HIGH: high temperature.

This section allows programming the amount of coffee to be brewed for each selected beverage. The bar allows you to adjust the exact amount of coffee to brew.

 button = "▲" (to increase the amount of coffee in the cup).

 button = "▼" (to reduce the amount of coffee in the cup).

This section allows you to program the amount of milk for each selected beverage. The bar allows you to adjust the exact amount of milk to dispense.

 button = "▲" (to increase the amount of milk in the cup).

 button = "▼" (to reduce the amount of milk in the cup).

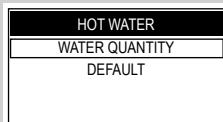

WATER QUANTITY

Hot Water Parameters (BEVERAGE MENU - >SPECIAL BEVERAGES)

These settings are valid only for programming hot water dispensing.

This section allows programming the amount of water to be dispensed when pressing the corresponding button. The bar allows you to adjust the exact amount of water to dispense.



“CLEAN” button = “▲” (to increase the amount of hot water in the cup).



“ ” button = “▼” (to reduce the amount of hot water in the cup).

Activating Steam (BEVERAGE MENU -> SPECIAL BEVERAGES)

These settings are valid only for activating the steam function. When the activation is complete the menu will be available, and the user will be able to activate it by following the procedure described on page 31.

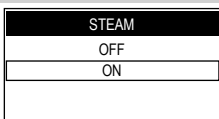
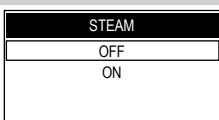
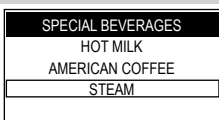

Press the “ ” button to select “STEAM” and the “ ” button to enter the menu.

Press the “ ” button to select “ON” and the “ ” button to activate the steam function.

Press the “ ” button once or more times to exit.

DEFAULT

Default Parameters

For each beverage it is possible to reset the original standard values assigned by the manufacturer. After selecting this function, the beverage customized settings are deleted.

Machine Programming

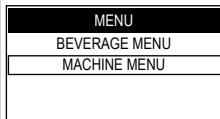
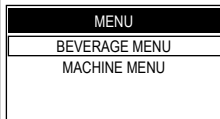

The machine allows you to customize the operating settings.

- 1 Press and hold the "MENU" button for 5 seconds to access the machine main menu.

When you enter the programming mode, the buttons have a different function:

- "OK" button = "OK" (confirms a selection or a change you have made)
- "CLEAN" button = "▲" (scrolls up the menu)
- "MENU" button = "▼" (scrolls down the menu)
- "MENU/ESC" button = "ESC" (confirms when you exit a selection)

- 2 Press the "MENU" button and the "OK" button to confirm the selection and enter the "MACHINE MENU".

General Menu

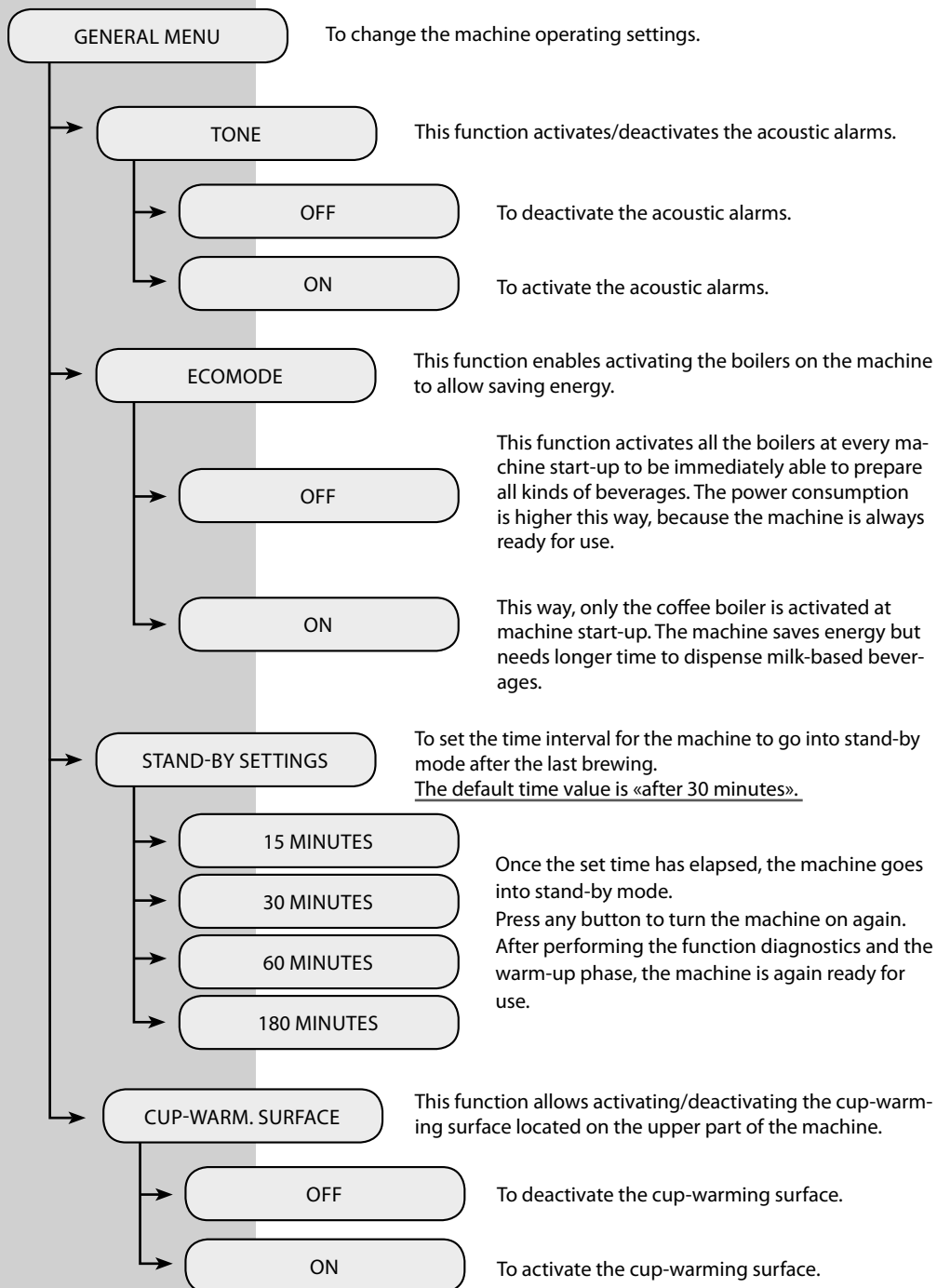

Display Menu

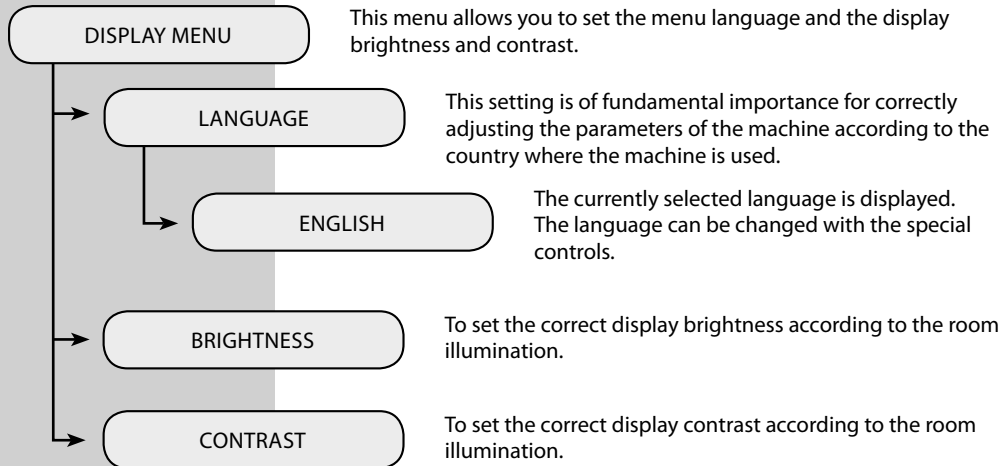

Water Menu

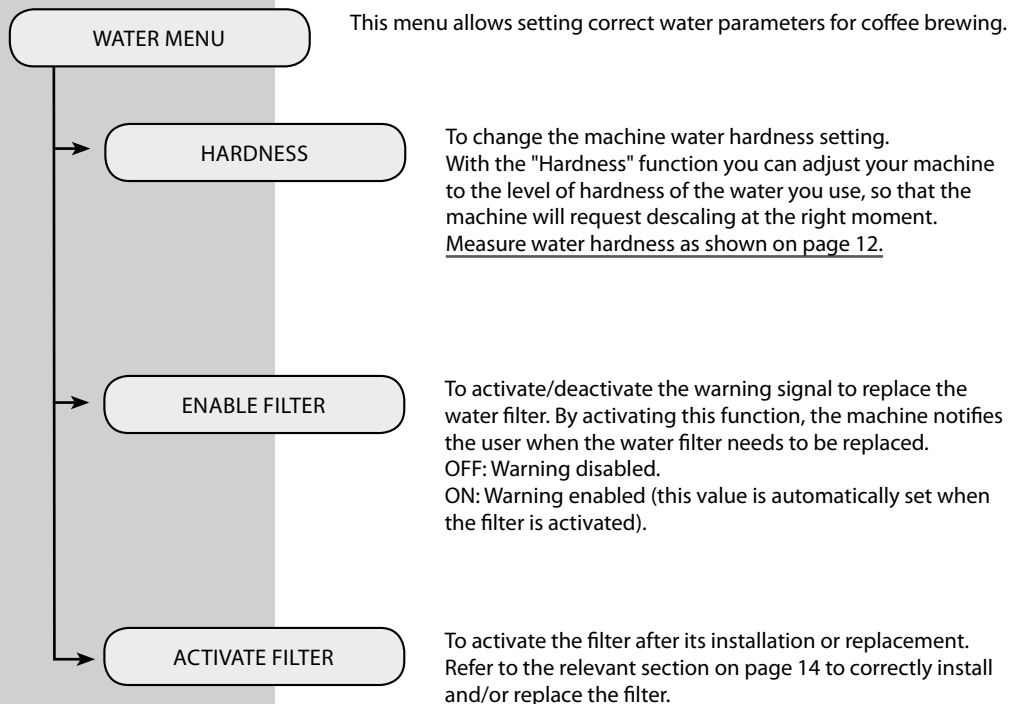

Maintenance

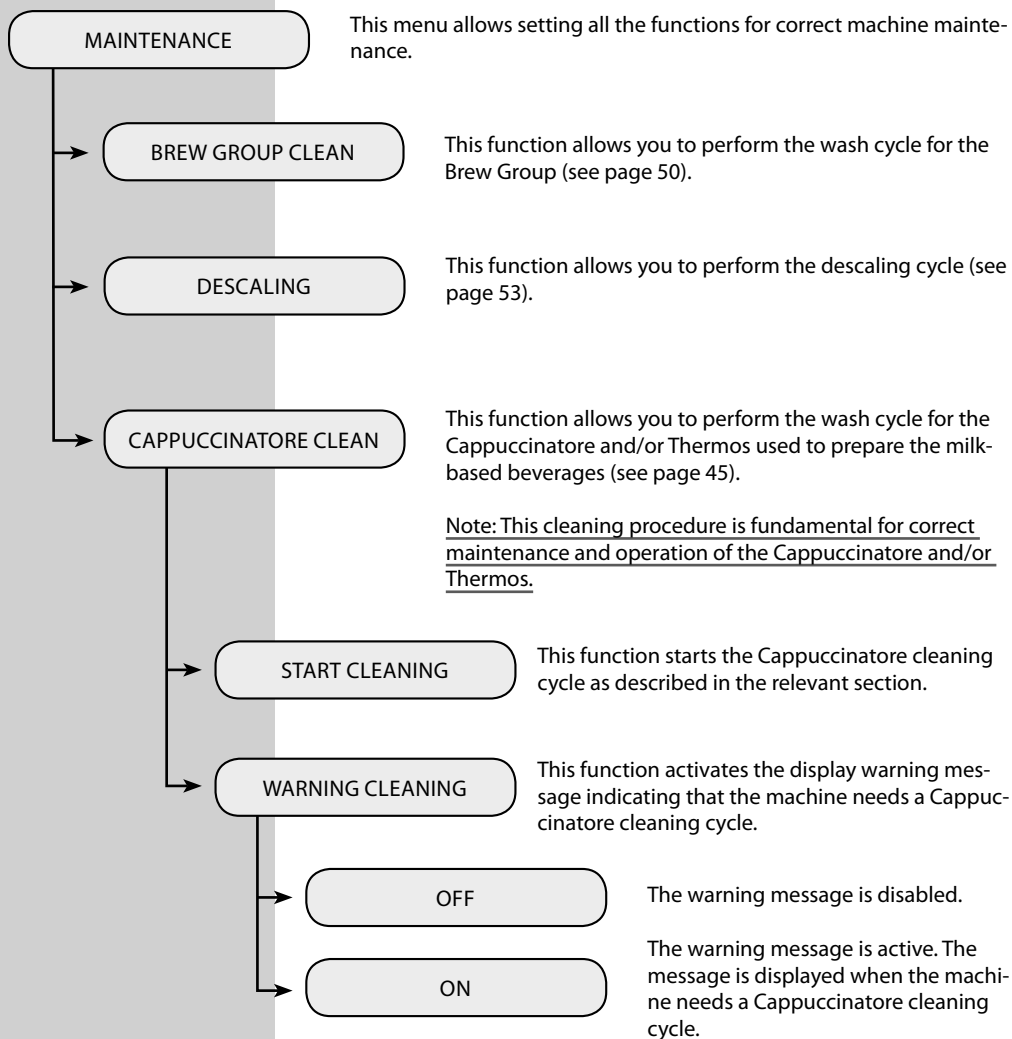

Factory Settings

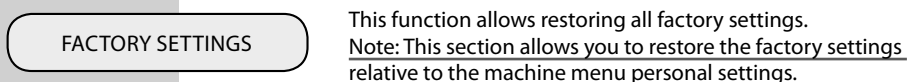

Cleaning and Maintenance

As some of the parts of your appliance come in contact with water and coffee during normal use, it is important that you clean your appliance regularly. This is an easy procedure with your Philips-Saeco Espresso machine. Just follow the steps indicated on the display and described below.

Not doing this will ultimately make your appliance stop working properly, and in this case repair is not covered under your warranty.

General Cleaning

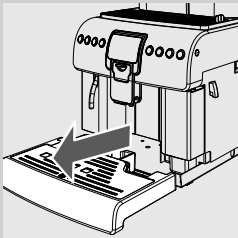

- 1 Empty and clean the drip tray and the coffee grounds drawer daily, with the machine turned on.

Note: We recommend cleaning the float and its seat to ensure perfect operation.

Note: Other maintenance and cleaning operations can only be carried out when the machine is cold and disconnected from the electrical network.

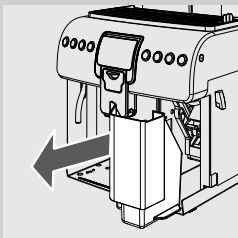

Do not immerse the machine in water.

Do not wash any of the removable parts in the dishwasher (except for the Cappuccinatore).

Do not use sharp objects or harsh chemical products (solvents) for cleaning.

Use a soft, dampened cloth to clean the machine.

Do not dry the machine and/or its parts using a microwave and/or standard oven.

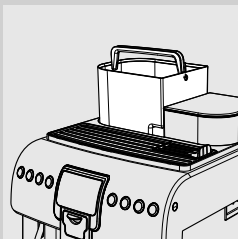

- 2 It is recommended to clean the water tank daily:
 - Remove the "INTENZA+" water filter (or remove the small white filter if you have not yet installed the "INTENZA+" water filter) from the water tank and wash it under running drinking water.
 - Reposition the "INTENZA+" water filter (or the small white filter if you have not yet installed the "INTENZA+" water filter) in its housing by gently pressing and turning it at the same time.
 - Fill the water tank with fresh drinking water.

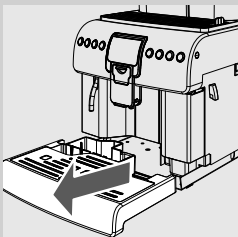

- 3 Empty and clean the drip tray daily. Perform this operation also when the float is raised.

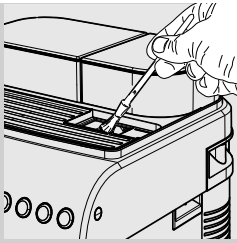

- 4 If you use the pre-ground coffee compartment, clean it every week with the supplied brush.

Cleaning the Cappuccinatore (After Each Use)

The Cappuccinatore must be washed and cleaned every time it is used.

The lack of cleaning before and after each use can affect the correct operation of the machine.

Danger of burning! Dispensing may be preceded by small jets of hot water.

For a quick cleaning, proceed as follows:



- 1 Make sure the Cappuccinatore complete with all its parts is correctly inserted.

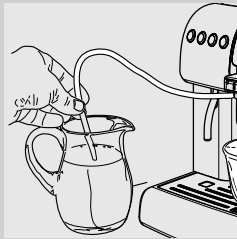

- 2 Insert the suction hose in a carafe containing clean water.

- 3 Place a container under the dispensing spout.

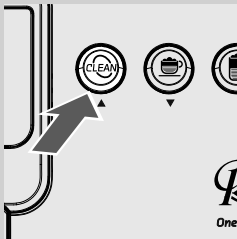

- 4 With the machine on, press the "CLEAN" button.

CAPPUCCINATORE CLEANING
 REPLACE MILK CONTAINER
 WITH ANOTHER ONE WITH
 FRESH WATER
 [OK] → YES [ESC] → NO

- 5 Press the "OK" button to start the cleaning cycle for the Cappuccinatore.

Note: To exit the cycle at any moment, press the "ESC" button.

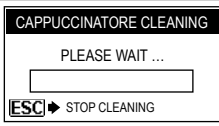

6 The machine warms the system up.

Once the warm-up is complete, the machine performs an assisted wash cycle for the Cappuccinatore.

Wait until the cycle is complete.

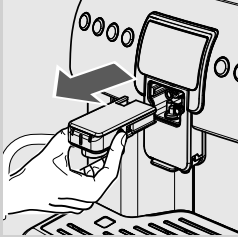

7 Only once the cycle is complete press the side buttons and remove the Cappuccinatore.



8 Place the cover back on the machine.

Important Note: We recommend removing the Cappuccinatore when not being used, in order to keep it clean.

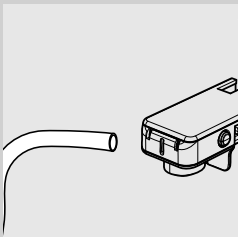

9 Remove the suction tube from the Cappuccinatore.

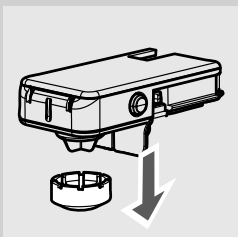

10 Remove the ring from the Cappuccinatore.

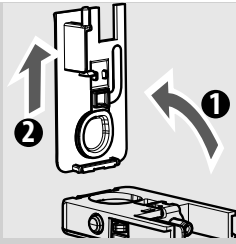

11 Rotate and lift the Cappuccinatore cover and remove it from the Cappuccinatore body.

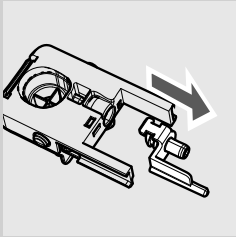

12 Remove the valve from the Cappuccinatore.

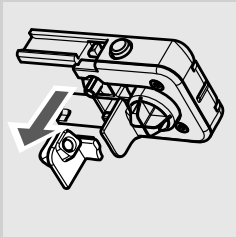

13 Remove the suction tube joint from the Cappuccinatore.

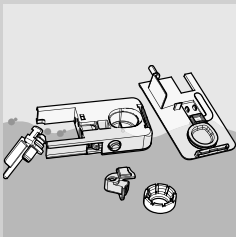

14 Wash the parts under running water.

Make sure any possible milk deposits/residues are removed.

After washing, reassemble the parts following the same procedure used for disassembly, but in reverse order.

Note: The "WARNING CLEANING" function can be activated, if desired; this function reminds you when the Cappuccinatore needs to be cleaned. To activate this function, refer to the machine programming section on page 38.

Day Cleaning - Thermos

The Thermos has to be cleaned every day to ensure proper operation.

Note: To clean the Thermos, the Cappuccinatore has to be installed. You can take the occasion to perform the daily cleaning of the Cappuccinatore at the same time.

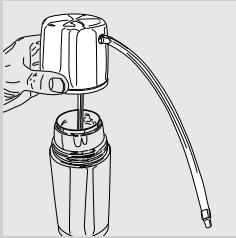

- 1 Rotate the lid and open the Thermos.



- 2 Remove the steel tube installed inside the Thermos lid. Wash it under lukewarm running water.

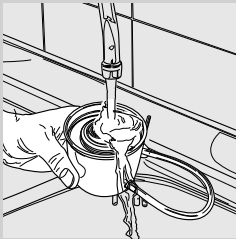

- 3 Wash the Thermos lid keeping the external rubber hose with plastic fitting inserted; in particular, wash the internal seal of the lid thoroughly.

After washing the Thermos lid, install the previously removed steel tube inside it. Without this tube milk cannot be frothed.

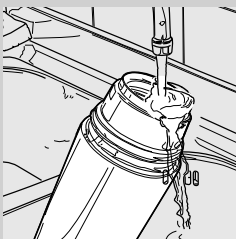

- 4 Wash the inside of the Thermos under lukewarm running water.

Make sure any possible milk deposits/residues are removed.

- 5 Fill the Thermos with fresh water and close the lid.

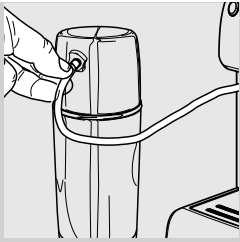

6 Connect the Thermos to the Cappuccinatore.



7 Place a container under the dispensing spout.

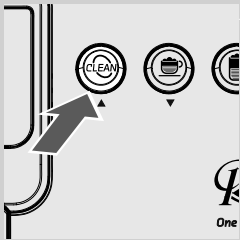

8 With the machine on, press the "CLEAN" button.

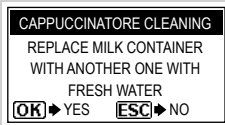

9 Press the "OK" button to start the cleaning cycle for the Cappuccinatore.

Note: To exit the cycle at any moment, press the "ESC" button.

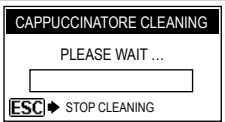

10 The machine warms the system up.

Once the warm-up is complete, the machine performs an assisted wash cycle for the Cappuccinatore.

Wait until the cycle is complete.

The wash cycle is now complete.

Refer to the following section for a thorough cleaning.

Monthly Cleaning - Cappuccinatore + Thermos (Thorough Cleaning)

Clean all the Cappuccinatore and Thermos parts thoroughly every month using the Saeco detergent supplied with the machine. The Saeco detergent may be purchased at your local dealer, at the Philips on-line shop at <http://shop.philips.com> or at authorised service centres.

The lack of cleaning before and after each use can affect the correct operation of the machine.

Danger of burning! Dispensing may be preceded by small jets of hot water.

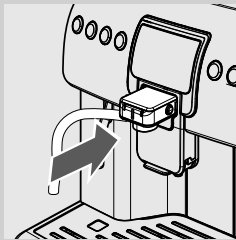
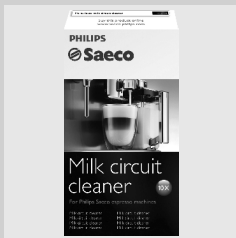

1 Make sure the Cappuccinatore is correctly placed.

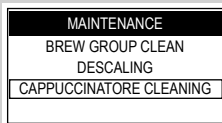

2 Press and hold the "MENU" button for 5 seconds to enter the machine main menu.

3 Press the "MACHINE MENU" button and select the "MACHINE MENU" option; press the "OK" button to enter the menu.

4 Press the "MACHINE MENU" button and select the "MAINTENANCE" option; press the "OK" button to enter the menu.

5 Press the "MACHINE MENU" button until the "CAPPUCCINATORE CLEANING" option can be selected. Press the "OK" button to confirm.

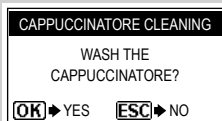

6 Press the "OK" button to start the cleaning cycle of the Cappuccinatore.

Note: If this option is confirmed, the cycle must be completed. Press the "ESC" button to exit until the ROYAL logo is displayed.

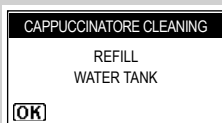

7 Fill the water tank and press the "OK" button to confirm.

CAPPUCCINATORE CLEANING
POUR DETERGENT
IN A CONTAINER
WITH 1/2 L WATER
OK

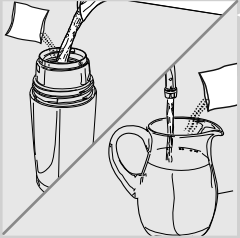

CAPPUCCINATORE CLEANING
PUT CAPPUCCINATORE
HOSE IN THE
CONTAINER
OK

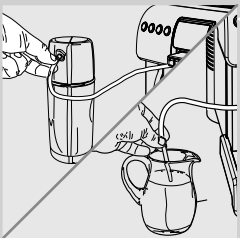

CAPPUCCINATORE CLEANING
PLACE A CONTAINER
UNDER THE
DISPENSING SPOUT
OK

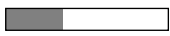

CAPPUCCINATORE CLEANING

8 Pour a solution bag in the Thermos or in a container with 1/2 (a half) litre of fresh drinking water.

9 Wait for the bag content to dissolve completely and then press the "☕" button to confirm.

10 Insert the clean hose (according to your choice)

- in the Thermos
- or
- directly in the container.

11 Press the "☕" button to confirm.

Drinking the solution dispensed during this procedure is strictly forbidden. The solution must be disposed of.

12 Place an empty container of at least 1 litre capacity under the dispensing spout and press the "☕" button to confirm.

13 The machine performs a wash cycle of the Cappuccinatore.

The bar shows the washing progress.

Wait until the cycle stops automatically.

CAPPUCCINATORE RINSING
REFILL
WATER TANK
OK

CAPPUCCINATORE RINSING
INSERT CAPPUCCINATORE
HOSE IN A CONTAINER
WITH 1/2 L WATER
OK



CAPPUCCINATORE RINSING
PLACE A CONTAINER
UNDER THE
DISPENSING SPOUT
OK

CAPPUCCINATORE RINSING

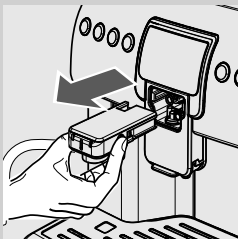

14 Fill the water tank and press the "☕" button to confirm.

15 Carefully wash:

- the Thermos
- or
- the container

used for the solution and fill it with 1/2 (a half) litre of fresh drinking water that will be used for rinsing.

Empty the container placed under the dispensing spout.

16 Insert the suction hose in the used container.

Press the "☕" button to confirm.

17 Place an empty container under the dispensing spout and press the "☕" button to confirm.

18 The machine performs a rinse cycle of the Cappuccinatore.

The bar shows the rinsing progress.

Wait until the cycle stops automatically. The machine will go back to the normal operating cycle.

19 Push the buttons located on the sides and remove the Cappuccinatore.

20 Wash all the Cappuccinatore parts, as described on page 41-42.

21 Wash all the Thermos parts (if the Thermos has been used), as described on page 43.

Important Note: We recommend removing the Cappuccinatore when not being used, in order to keep it clean.

Brew Group

Weekly Cleaning - Brew Group

The brew group should be cleaned every time the coffee bean hopper is filled or at least once a week.

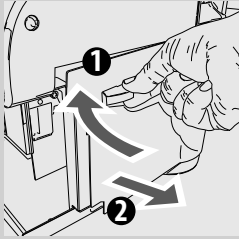

- 1** Turn off the machine by pressing the power button and remove the plug from the socket.

- 2** Remove the drip tray and the coffee grounds drawer.

Open the service door:

- 1) Rotate the lever clockwise by 90°.
- 2) Pull the door towards you.

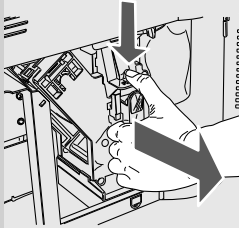

- 3** Remove the brew group: Pull it by the handle and press the «PRESS» button. The brew group must be washed only with lukewarm water with no detergent.

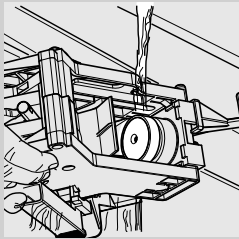

- 4** Wash the brew group with lukewarm water and carefully wash the upper filter. Before placing the Brew Group in its housing, make sure there is no water left in the brewing chamber.

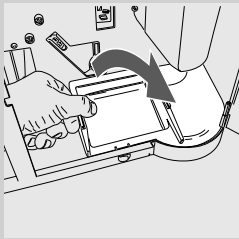

- 5** Lift the rear part of the inner tray and unlock it.

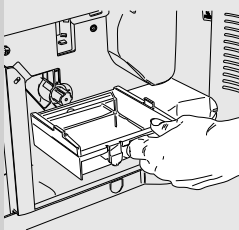

- 6** Remove the inner tray, wash and reposition it in its seat.

Note: When inserting the tray follow the same procedure used for disassembly, but in reverse order.

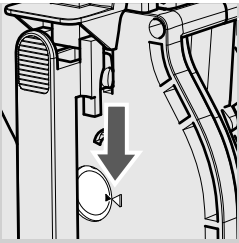

- 7** Make sure the Brew Group is in the rest position; the two reference signs must match.
If they do not match, proceed as described in step (8).

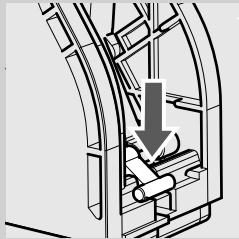

- 8** Make sure that the lever is in contact with the brew group base.

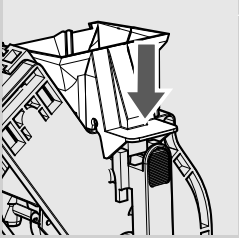

- 9** Make sure that the hook to lock the Brew Group is in the correct position; to check its position firmly press the "PRESS" button.

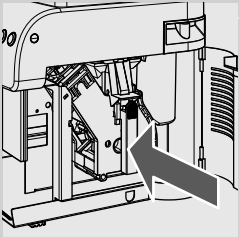

- 10** Insert the Brew Group in its seat again until it locks into place WITHOUT pressing the "PRESS" button.

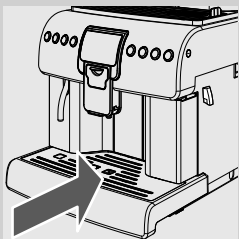

- 11** Insert the coffee grounds drawer and the drip tray. Close the service door.



Cleaning the Brew Group with the "Coffee Oil Remover"

Besides weekly cleaning, we recommend you to carry out this cleaning cycle with the "Coffee Oil Remover" after about 500 cups of coffee or every month. This operation completes the maintenance process for the Brew Group.

The "Coffee Oil Remover" for cleaning the Brew Group and the "Maintenance Kit" can be purchased at your local dealer, at the Philips online shop at <http://shop.philips.com> or at authorised service centres.

Warning: The "Coffee Oil Remover" does not have any descaling property. For the descaling cycle use the Saeco descaling solution and follow the steps described in the "Descaling" chapter.

The wash cycle cannot be stopped.
Do not leave the machine unattended during this operation.

Warning! Drinking the solution dispensed during this procedure is strictly forbidden. The solution must be disposed of.

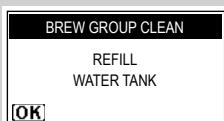
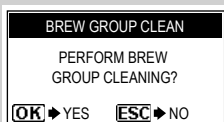
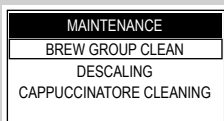

- 1 Press and hold the "MENU" button for 5 seconds to enter the machine main menu.
- 2 Press the "BREW" button and the "OK" button to confirm the selection and enter the "MACHINE MENU".
- 3 Press the "BREW" button and select the "MAINTENANCE" option; press the "BREW" button to enter the menu.
- 4 Press the "OK" button to confirm.
- 5 Press the "BREW" button to start the cleaning cycle of the brew group.

Note: If this option is confirmed the cycle must be completed. Press the "ESC" button to exit.

- 6 Fill the water tank and press the "OK" button to confirm.

BREW GROUP CLEAN
INSERT GROUP
CLEAN TAB
OK

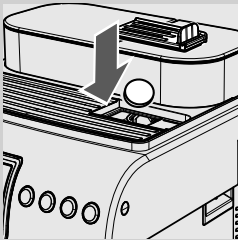

BREW GROUP CLEAN
PLACE A CONTAINER
UNDER THE
DISPENSING SPOUT
OK

BREW GROUP CLEAN
Progress bar showing approximately 10% completion.

- 7** Insert the cleaning tablet into the pre-ground coffee compartment and press the “☕” button to confirm.

- 8** Place a container under the dispensing spout and press the “☕” button to confirm.

- 9** The machine completes the cycle automatically.

Note: Once the cycle is complete, the machine goes back to its normal operating mode.

Brew Group Lubrication

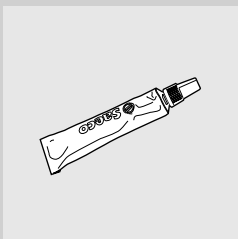

Lubricate the Brew Group after approximately 500 cups of coffee or once a month. The grease to lubricate the Brew Group and the complete "Service Kit" may be purchased at your local dealer, at the Philips on-line shop at <http://shop.philips.com> or at authorised service centres.

Note: To display the number of coffee cups brewed, please refer to the "COUNTERS" menu in the "BEVERAGE MENU" menu.

Before lubricating the brew group clean it under running water as described in the chapter "Weekly Cleaning - Brew Group".

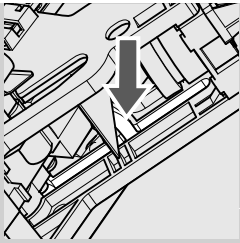

- 1** Lubricate the brew group guides using the Saeco grease only. Apply the grease evenly on both side guides.

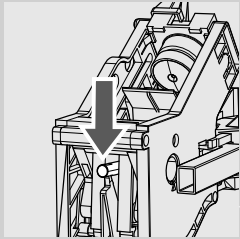
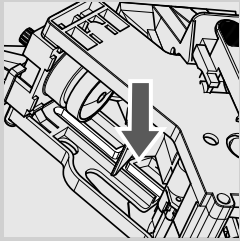

- 2** Lubricate also the shaft.

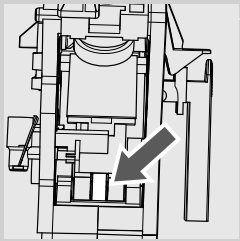

- 3** Insert the Brew Group in its seat again until it locks into place **WITHOUT** pressing the "PRESS" button.

Note: the detailed instructions to prepare the brew group and insert it correctly in the machine can be found on page 49 (point 7, 8, 9 and 10) of the section "Weekly Cleaning - Brew Group".

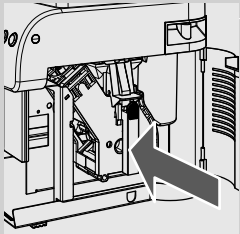

- 4** Insert the coffee grounds drawer and the drip tray. Close the service door.

Descaling



Limescale is a natural part of the water used for the machine operation. It needs to be removed regularly as it may clog the water and coffee circuit of your appliance.

This is an easy procedure with your Philips-Saeco machine.

The advanced electronics tells you on the display of the machine (in clear symbols) when descaling is needed. Just follow the steps described below.

Not doing this will ultimately make your appliance stop working properly, and in this case repair is not covered under your warranty.

Use the Saeco descaling product only. Its formula has been designed to ensure better machine performance and operation for its whole operating life. If correctly used, it also avoids alterations in the brewed product. The descaling solution and the complete "Maintenance Kit" may be purchased at your local dealer, at the Philips on-line shop at <http://shop.philips.com> or at authorised service centres.

Warning! Never drink the descaling solution or any products dispensed until the cycle has been carried out to the end. Never use vinegar as a descaling solution.

- 1 Turn on the machine by pressing the ON/OFF button. Wait for the machine to finish its rinse and warm-up process.

Warning! Remove the "Intenza" filter before adding the descaling solution.

- 2 Press and hold the "MENU" button for 5 seconds to access the machine main menu.
- 3 Press the "☕" button and the "OK" button to confirm the selection and enter the "MACHINE MENU".
- 4 Press the "☕" button and select the "MAINTENANCE" option; press the "OK" button to enter the menu.
- 5 Press the "☕" button and select the "DESCALING" option; press the "OK" button to enter the menu.

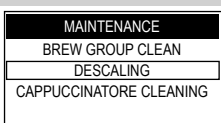

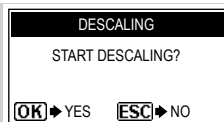

6 Press the "☕
OK" button to start the DESCALING cycle.

*Note: If this option is confirmed, the rest of the cycle must be completed. Press the "☕
ESC" button to exit.*

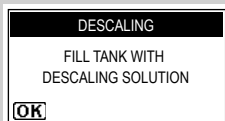

7 Pour the entire content of the Saeco concentrated descaling solution into the water tank and then fill the tank with fresh drinking water up to the level indicated by the  icon.

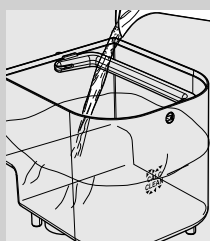

Place the tank back in the machine. Press the "☕
OK" button.

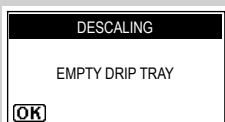

8 Remove any liquids from the drip tray and insert it back into the machine.

Press the "☕
OK" button.

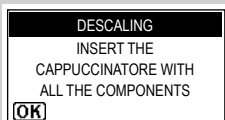
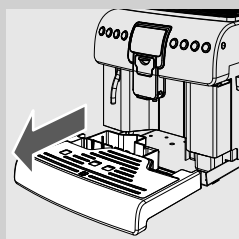

9 Insert the complete Cappuccinatore into the machine and remove the dispensing spout.

Press the "☕
OK" button.

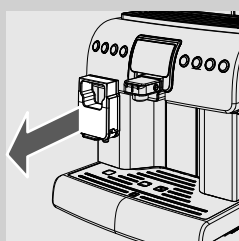

Note: Keep the suction tube removed from the Cappuccinatore while the descaling cycle is performed.

DESCALING
PLACE A CONTAINER
UNDER MILK AND HOT
WATER SPOUTS
OK

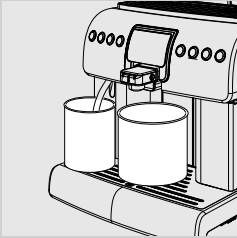

DESCALING
STEP 1/2
ESC PAUSE

DESCALING
RINSE TANK &
FILL WITH FRESH WATER
OK

DESCALING
EMPTY DRIP TRAY
OK

DESCALING
INSERT THE
CAPPUCCINATORE WITH
ALL THE COMPONENTS
OK

DESCALING
PLACE A CONTAINER
UNDER MILK AND HOT
WATER SPOUTS
OK

- 10** Place a container under the hot water wand and a large enough container under the Cappuccinatore.

Press the "☺" button.

Note: Use a container of at least 1.5 litre capacity.

If you do not have a container of this capacity, pause the cycle by pressing the "☺" button, empty the container, place it back in the machine and restart the cycle by pressing the "☺" button.

- 11** At this point the machine will start dispensing the descaling solution at intervals (the bar shows the cycle progress).

- 12** When the solution in the tank is finished, the machine requests to empty and rinse the tank with fresh drinking water.

- 13** Rinse the water tank thoroughly and refill it with fresh drinking water. Insert the tank into the machine. Press the "☺" button.

- 14** Empty the containers used to collect the liquid dispensed by the machine.

- 15** Remove any liquids from the drip tray and insert it back.

Press the "☺" button.

- 16** Check that the Cappuccinatore is placed in the machine.

Press the "☺" button.

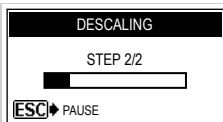

- 17** Place a container under the hot water wand and a large enough container under the Cappuccinatore.

Press the "☺" button.



18 The machine performs the rinse cycle.

Note: A default amount of water is needed for the rinse phase. This allows performing an ideal rinse cycle to ensure the best conditions to brew products. The message about filling the tank for the rinse cycle is normal, as it is part of the procedure.

Note: The rinse cycle may be paused by pressing the “” button. To resume the cycle, press the “” button again. This allows you to empty the container or to go away for a short period of time.

19 Once the rinse cycle is complete, the machine carries out the warm-up and rinse cycle to prepare for product brewing.

20 Empty the containers used to collect the liquid dispensed by the machine and reassemble the dispensing spout.

21 The machine is now ready for use.







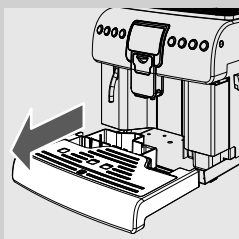

Note:





- *The descaling solution must be disposed of according to the manufacturer's instructions and/or regulations in force in the country of use.*
- *After completing the descaling cycle:*
 - 1 *Wash the brew group as described in the “Brew Group” section in the “Cleaning and Maintenance” chapter.*
 - 2 *Rinse the Cappuccinatore under running water.*

When the descaling cycle is complete, we recommend emptying the drip tray.

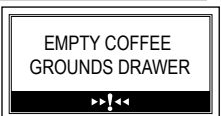
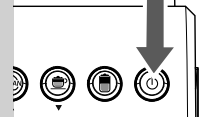

LCD Display Warnings

Help Message Displayed	How to Reset the Message
	To restore the machine operation, close the service door.
	Insert the drip tray.
	Insert the coffee grounds drawer.
	Close or correctly place the coffee bean hopper inner lid to be able to prepare any product.
	Remove the tank and fill it with fresh drinking water.
	Insert the Brew Group into its seat.
	An operation has been selected that requires dispensing milk. Insert the Cappuccinatore in the machine as specified in the manual.
	The selected operation requires milk dispensing. Insert the previously removed valve in the Cappuccinatore as described in the manual (see step 12 on page 42).
	Fill the coffee bean hopper with coffee beans.

Help Message Displayed	How to Reset the Message
	<p>The machine requests a descaling cycle. When this message is displayed, it is still possible to use the machine, but its correct operation might be affected. Damages caused by failure to descale the machine are not covered by warranty.</p>
	<p>The machine requests the "Intenza" water filter to be replaced with a new one. Replace the filter as described on page 14.</p> <p>The alarm is displayed only if the "Enable Filter" function is set to "ON". (see page 37).</p>
	<p>The machine reminds that after a few cycles it will be necessary to empty the coffee grounds drawer. This message does not prevent the machine from brewing some more products.</p>
	<p>Remove the coffee grounds drawer and empty the coffee grounds into a suitable container. <u>Note: The coffee grounds drawer must be emptied only when the machine asks for it and with the machine turned on. If you empty the drawer with the machine turned off it will not record the emptying operation.</u></p>
	<p>Blinking red light. Machine in Stand-by.</p> <p>The Stand-by settings can be changed (see page 36).</p> <p>Press the "⏻" button</p>
	<p>An event has occurred which needs the machine to be restarted. Take note of the code (E xx) shown at the bottom. Turn off the machine, wait for 30 seconds and then turn it on again. If the problem persists, contact the service centre.</p>
	<p>If this page is displayed after starting the machine, this means that the descaling cycle is needed.</p> <p>Press the "☺" button to enter the descaling menu and refer to the relevant section.</p> <p>Press the "⏻" button to go on using the machine.</p> <p><u>We remind you that damage caused by failure to descale the machine are not covered by warranty.</u></p>

Troubleshooting

Machine actions	Causes	Solutions
The machine does not switch on.	The machine is not plugged and/or the power button is positioned on "0".	Plug the machine and/or switch the power button to "I".
Coffee is not hot enough.	The cups are cold.	Preheat the cups with hot water.
	Cup-warming surface deactivated	Activate the cup-warming surface and wait for the cups to warm.
Coffee has not enough crema. (See note)	The blend is unsuitable, coffee is not freshly roasted or the grind is too coarse.	Change coffee blend or adjust the grind as explained in section "Adjusting the Coffee Grinder".
The machine takes a long time to warm up or the amount of water dispensed from the wand is too little.	The machine circuit is clogged by limescale.	Descale the machine.
Bubbles form at the Cappuccinatore spout while dispensing milk.	The tube fittings are not connected properly or are not completely inserted in the Cappuccinatore and/or Thermos.	Insert the suction tube completely in the Cappuccinatore and/or Thermos (if used).
Steam comes out of the Cappuccinatore when the Thermos is connected and/or when sucking milk.	There is no milk in the Thermos and/or container any more.	Check for milk presence. If necessary, fill in the Thermos again or replace the milk container with a new one.
	Thermos internal tube is not present.	Install the tube in the Thermos lid.
The Brew Group cannot be removed.	The Brew Group is out of place.	Turn the machine on. Close the service door. The brew group automatically returns to the initial position.
	The coffee grounds drawer is inserted.	Remove the coffee grounds drawer before removing the brew group.
The machine grinds the coffee beans but no coffee comes out. (See note)	The Brew Group is dirty.	Clean the Brew Group ("Brew Group" section).
	The dispensing spout is dirty.	Clean the dispensing spout.
Coffee is too weak. (See note)	Too low dose	Adjust the amount of coffee to be ground.
Coffee is brewed slowly. (See note)	The coffee grind is too fine.	Change coffee blend or adjust the grind as explained in section "Adjusting the Coffee Grinder".
	The Brew Group is dirty.	Clean the Brew Group ("Brew Group" section).
Coffee leaks out of the dispensing spout.	The dispensing spout is clogged or in the wrong position.	Clean the dispensing spout and its holes. Position the dispensing spout correctly.

Note: These problems can be considered normal if the coffee blend has been changed or if the machine has just been installed.

Please, contact our consumer care help line at the phone number listed at the last page of this document for any problems not covered in the above table or when the suggested solutions do not solve the problem.

Technical Specifications

The manufacturer reserves the right to make changes to the technical specifications of the product.

Nominal voltage - Power rating - Power supply	See label on the inside of the service door
Housing material	Thermoplastic material / Metal
Size (w x h x d) (mm)	336 x 380 x 450
Weight	15 kg
Power cord length	1.2 m
Control panel	On the front
Cappuccinatore	Special for cappuccino
Water tank	2.2 litres - Removable type
Coffee bean hopper capacity (g)	320
Coffee grounds drawer capacity	19
Pump pressure	15 bar
Boiler	Stainless steel type
Safety devices	Thermostats/Thermal protectors

Disposal

- The packing materials can be recycled.
- Appliance: Unplug the appliance and cut the power cord.
- Deliver the appliance and power cord to a service center or public waste disposal facility.

This product complies with eu directive 2002/96/ec.



The symbol  on the product or on its packaging indicates that this product may not be treated as household waste. Instead it shall be handed over to the applicable collection point for the recycling of electrical and electronic equipment.

By ensuring this product is disposed of correctly, you will help prevent potential negative consequences for the environment and human health, which could otherwise be caused by inappropriate waste handling of this product. For more detailed information about recycling of this product, please contact your local city office, your household waste disposal service or the shop where you purchased the product.



Service

We want to ensure that you remain satisfied with your Philips Saeco Espresso coffee machine.

If not done already, please register your purchase on "www.philips.com/welcome" so that we can stay in contact with you and send you cleaning and descaling reminders.

For cleaning and descaling operations, use SAECO products only. You can purchase these products and other spare parts at your local dealer, at an authorised service centre or at the Philips on-line shop by indicating one of the following codes:

Descaling solution: CA6700

"Intenza+" filter: CA6702

Coffee Oil Remover: CA6704

Milk circuit cleaning system: CA6705

For cleaning and descaling, use SAECO products only. You can purchase these on-line at the Philips on-line shop at:

- NL <http://shop.philips.nl>
- BE <http://shop.philips.be>
- FR <http://shop.philips.fr>
- DK <http://shop.philips.dk>
- DE <http://shop.philips.de>
- ES <http://shop.philips.es> or <http://tienda.philips.es>
- IT <http://shop.philips.it>
- SE <http://shop.philips.se>

If you have questions about your appliance, e.g. about its installation, use, cleaning or descaling, please refer to this user manual or go for the latest updates to www.philips.com/support.

Alternatively, you may contact our toll free consumer care help line at the phone number listed on the last page of this document.

Our qualified service staff will help you and, if needed, trouble shoot your appliance by phone and where possible provide a solution during the call. If this is not possible we will help you to initiate any necessary repair in the shortest possible time and with maximum convenience.

CONSUMER RELATIONS DESKS

For Downloads & FAQs visit our Customer Support Website: www.philips.com/support

Argentina:0800-888-7532 (número gratuito)
Australia:1300 363 391 option 3 (toll free)
Bahrain:+973 17700424
Baltics:
..... Estonia:	8000100288 (tasuta)
..... Latvia:	6616 3264 (pašvaldību līmenis)
..... Lithuania:	8 5 214 0294 (vietinis tarifas)
Belgium:070 700 036 (€ 0,15 p/min)
Brazil:0800 701 0203 (Demais localidades)
.....	(11) 2121 0203 (Grande São Paulo)
Bulgaria:+359 02 4916274 (национални тарифа)
Canada:1-800 371 7597 (local toll free)
Czech Republic:228880896 (vnitrostátní sazby)
China:4008 800 008
Croatia:+385 (01) 777 66 02
Denmark:35 44 41 30 (lokal takst)
Germany:0800 000 7520 (für Anrufe aus dem deutschen Festnetz, kostenfrei) –
.....	0180 501 06 71 (für Anrufe aus dem deutschen Mobilfunknetz kostenpflichtig, max. 0,42 €/Min)
España:902881082 (0,10€ establecimiento de llamada + 0,08€/min)
France:0157324051 (tarif national)
Greece:2111983029
Hong Kong:852 2619 9663
Israel:03-6458844
Iran:+98 21 2227 9353
Ireland:08 18 21 01 41 (National call)
Italy:02 45279074 (tariffa nazionale)
Japan:813-3-3555-0156
Korea:080-600 6600 (toll free)
Kuwait:1 80 35 35.
Lebanon:961 1 684900
Luxembourg:24871095 (tarif national/nationaler Tarif)
Magyarország:(061) 700 8152 (nemzeti mérték)
Malaysia:1800 880 180
Mexico:01800 504 6200 (número gratuito)
Netherlands:0900 202 11 77 (€ 0,10/min*)
Norway:22971950 (nasjonale Tariffnr.)
Österreich:0800 180 016 (für Anrufe aus dem österreichischen Festnetz, kostenfrei)
.....	0820401132 (für Anrufe aus dem österreichischen Mobilfunknetz kostenpflichtig, Preis variiert je nach Mobilfunkanbieter)
Poland:22 397 15 06 (Stawka lokalna)
Portugal:707780226 (0,12€ (0,30€ móvel))
Romania:031 6300043 (accesibil din orice rețea, cu tarif local)
Russia/Россия:+7 495 961-1111 (без выходных) - 8 800 200-0880 (без выходных, звонок бесплатный, в т.ч. с мобильных телефонов)
Singapore:+65 68823999
Slovenija:01 888 83 13 (nacionalnih tarif)
Slovenská republika:2 332 155 70 (vnitrostátnie tarifa)
Suomi:09 88 62 50 41 (kansallisten kutsu)
South Africa:021-425 6169
Sverige:0857929067 (nationella samtal)
Switzerland:0800 002 050 (für Anrufe aus dem schweizer Festnetz, kostenfrei) +
.....	0848 000 292 (für Anrufe aus dem schweizer Mobilfunknetz kostenpflichtig, Preis variiert je nach Mobilfunkanbieter)
Ukraine:0-800-500-697 (усі дзвінки з стаціонарних телефонів в межах України безкоштовні)
United Arab Emirates (Dubai):	+971 4 2310300
United Kingdom:0844 338 04 89 (0,05GBP/minute)
USA:1-800-933-7876 (toll free)
Taiwan:0800 231099
Thailand:+6626528652



The manufacturer reserves the right to make changes without prior notice.

www.philips.com/saeco



15002770

Rev.06 del 15-07-12