

Register your product and get support at
www.philips.com/welcome

English

SYNTIA

Type HD8836 / HD8837
SUP 037DR

OPERATING INSTRUCTIONS



EN

READ THESE OPERATING INSTRUCTIONS CAREFULLY BEFORE USING THE MACHINE.

CE

PHILIPS
 **Saeco**

IMPORTANT SAFEGUARDS

When using electrical appliances, basic safety precautions should always be followed, including the following:

1. Read all instructions.
2. Do not touch hot surfaces. Use handles or knobs.
3. To protect against fire, electric shock and injury to persons do not immerse cord, plugs, or appliance in water or other liquid.
4. Close supervision is necessary when the appliance is used by or near children.
5. Unplug from outlet when not in use and before cleaning. Allow to cool before putting on or taking off parts, and before cleaning the appliance.
6. Do not operate any appliance with a damaged cord or plug or after the appliance malfunctions, or has been damaged in any manner. Return appliance to the nearest authorized service facility for examination, repair or adjustment.
7. The use of accessory attachments not recommended by the appliance manufacturer may result in fire, electric shock or injury to persons.
8. Do not use outdoors.
9. Do not let cord hang over edge of table or counter, or touch hot surfaces.
10. Do not place on or near a hot gas or electric burner, or in a heated oven.
11. Always attach plug to appliance first, then plug cord into wall outlet. To disconnect, turn any control to "off", then remove plug from wall outlet.
12. Do not use appliance for other than intended use.
13. Save these instructions.

SAVE THESE INSTRUCTIONS

CAUTION

This appliance is for household use only. Any servicing, other than cleaning and user maintenance, should be performed by an authorized service center. Do not immerse machine in water. To reduce the risk of fire or electric shock, do not disassemble the machine. There are no parts inside the machine serviceable by the user. Repair should be done by authorized service personnel only.

1. Check voltage to be sure that the voltage indicated on the nameplate corresponds with your voltage.
2. Never use warm or hot water to fill the water tank. Use cold water only.
3. Keep your hands and the cord away from hot parts of the appliance during operation.
4. Never clean with scrubbing powders or harsh cleaners. Simply use a soft cloth dampened with water.
5. For optimal taste of your coffee, use purified or bottled water. Periodic descaling is still recommended every 2-3 months.
6. Do not use caramelized or flavored coffee beans.

INSTRUCTIONS FOR THE POWER SUPPLY CORD

- A. A short power-supply cord (or detachable power-supply cord) is to be provided to reduce risks resulting from becoming entangled in or tripping over a longer cord.
- B. Longer detachable power-supply cords or extension cords are available and may be used if care is exercised in their use.
- C. If a long detachable power-supply cord or extension cord is used,
 1. The marked electrical rating of the detachable power-supply cord or extension cord should be at least as great as the electrical rating of the appliance
 2. If the appliance is of the grounded type, the extension cord should be a grounding-type 3-wire cord, and
 3. The longer cord should be arranged so that it will not drape over the counter top or table top where it can be pulled on by children or tripped over.

GENERAL INFORMATION

The coffee machine is suitable for preparing espresso coffee using either coffee beans or ground coffee and is equipped with a device to dispense steam and hot water. The structure of the machine has been designed for domestic use only and is not suitable for continuous professional-type operation.

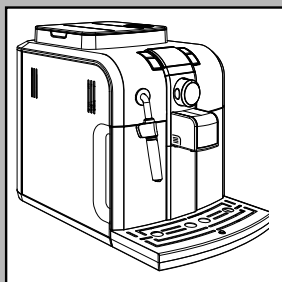

Keep these operating instructions in a safe place and make them available to anyone who may use the coffee machine.

For further information or in case of problems that are not included or not completely explained in these instructions, please contact an authorized service center.



Warning. No liability is held for damage caused by:

- **Incorrect use not in accordance with the intended purposes;**
- **Repairs not carried out by authorized service centers;**
- **Tampering with the power cord;**
- **Tampering with any parts of the machine;**
- **Storage or use of the machine at a temperature outside the operating temperature range (+15°C / +45°C);**
- **The use of non-original spare parts and accessories.**

In these cases, the warranty shall be deemed null and void.

SAFETY REGULATIONS



Never allow water to come into contact with any of the electrical parts of the machine: Danger of short circuit! Steam and hot water may cause scalding! Do not direct the steam/hot water wand towards body parts. Carefully handle the steam/hot water wand by its grip: Danger of scalding!

Intended Use

The coffee machine is intended for domestic use only. Do not make any technical changes or use the machine for unauthorized purposes since this would create serious hazards! The appliance is not to be used by persons (including children) with reduced physical, mental or sensory abilities or with limited experience and/or expertise, unless they are supervised by a person responsible for their safety, or they are instructed by this person on how to properly use the machine.

Power Supply - Power Cord

Only connect the coffee machine to a suitable socket.

The voltage must correspond to that indicated on the machine label located on the inside of service door.

Never use the coffee machine if the power cord is defective or damaged.

If damaged, the power cord must be replaced by the manufacturer or an authorized service center. Do not pass the power cord around corners, over sharp edges or over hot objects and keep it away from oil. Do not use the power cord to carry or pull the coffee machine.

Do not pull out the plug by the power cord or touch it with wet hands. Do not let the power cord hang freely from tables or shelves.

For the Safety of Others

Keep children under control to prevent them from playing with the product. Children are not aware of the risks related to electric household appliances. Do not leave the machine packaging materials within the reach of children.

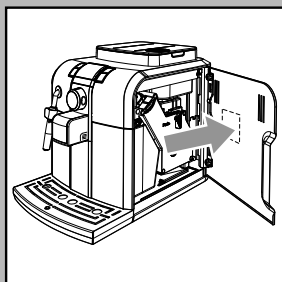

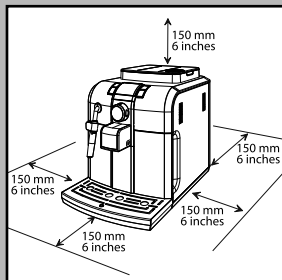

Danger of Burns

Never direct the steam/hot water wand towards yourself or others: **Danger of scalding!** Always use the handles or knobs provided.

Machine Location - Suitable Location for Operation and Maintenance

For best use, it is recommended to:

- Choose a safe, level surface, where there will be no danger of overturning it or being injured.
- Choose a location that is sufficiently well-lit, clean and near an easily reachable socket.
- Provide for a minimum distance from the sides of the machine as shown in the illustration.
- During machine turning on/off, it is recommended to place an empty glass under the dispensing head.

Do not keep the machine at a temperature below 0°C (32°F).

Frost may damage the machine.

Do not use the coffee machine outdoors.

In order to prevent its housing from melting or being damaged, do not place the machine on very hot surfaces and close to open flames.

Storing the Machine - Cleaning

Before cleaning the machine, turn it off by pressing the ON/OFF button, and then switch the power button to "0". Remove the plug from the socket.

Wait for the machine to cool down.

Never immerse the machine in water!

It is strictly forbidden to tamper with the internal parts of the machine.

Water left in the tank for several days should not be consumed. Wash the tank and fill it with fresh drinking water.

If the machine will not be used for a long time, dispense water from the steam wand, and carefully clean the Pannarello (if supplied), then turn it off and unplug it.

Store it in a dry place, out of the reach of children.

Keep it protected from dust and dirt.

Servicing / Maintenance

In case of failure, problems or a suspected fault resulting from the falling of the machine, immediately remove the plug from the socket.

Never attempt to operate a faulty machine.

Servicing and repairs may only be carried out by authorized service centers.

All liability for damages resulting from work not carried out by professionals is declined.

Fire Safety Precautions

In case of fire, use carbon dioxide (CO₂) extinguishers. Do not use water or dry powder extinguishers.

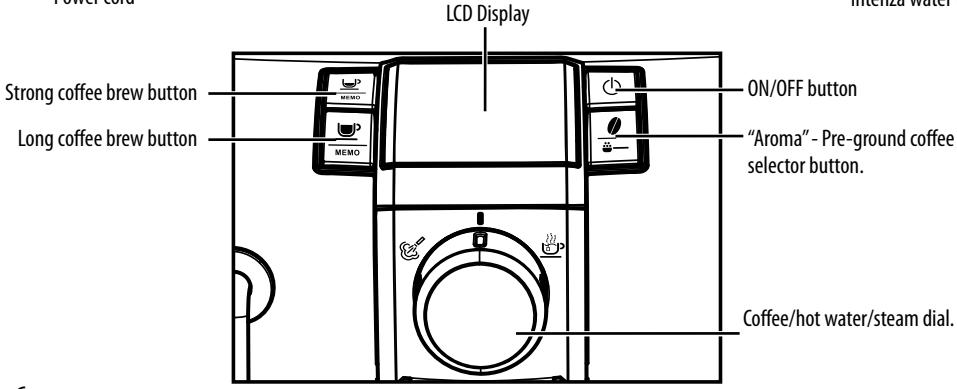
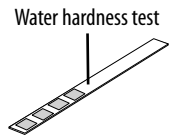
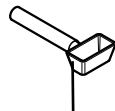
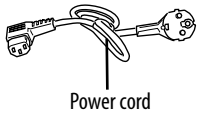
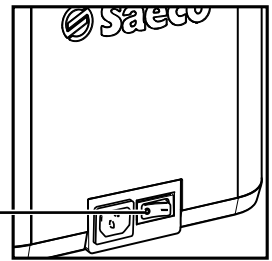
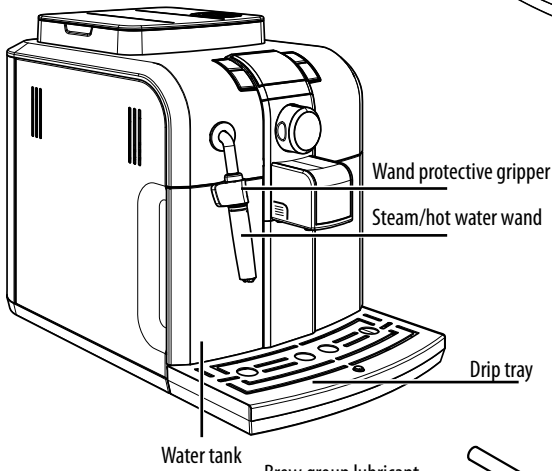
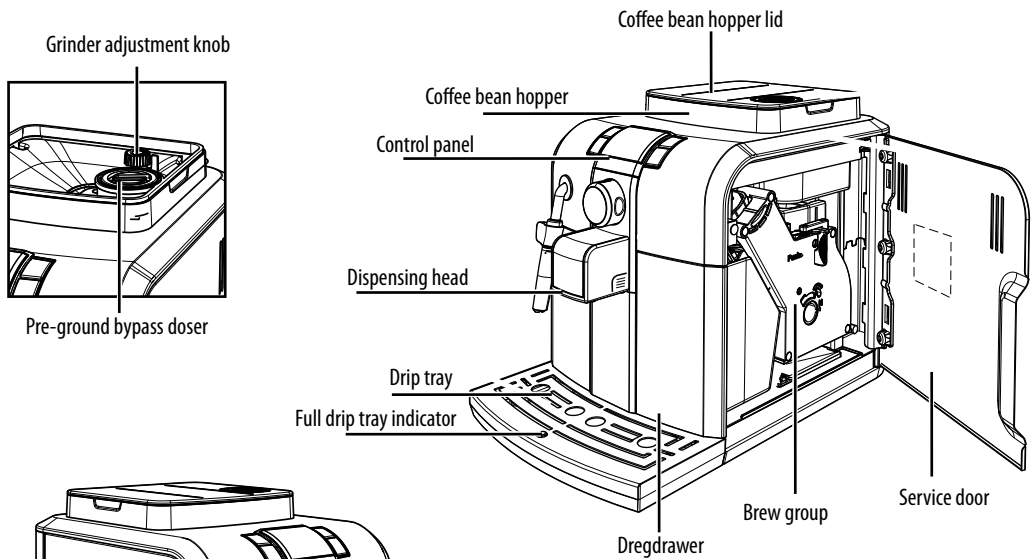

INSTALLATION

For your own and for other people's safety, carefully follow the instructions provided in the "Safety Regulations" section.

Machine Packaging

The original packaging has been designed and constructed to protect the machine during transport. We recommend keeping the packaging material for possible future transport.

Preliminary Operations

- Remove the coffee bean hopper lid and the drip tray with grill from the packaging.
- Remove the coffee machine from the packaging and position it in a place that meets the requirements described in the safety regulations.
- Place the drip tray with grill into its appropriate seat on the machine. Make sure it is fully inserted and clicks into place.
- Place the coffee bean hopper lid on the bean hopper.

i Note: Insert the plug in the machine and in the wall socket only when indicated and check that the power button is switched to "0".

i Important Note: Carefully read the explanations of all the warnings displayed on the LCD control panel (section "LCD Display Warnings").

! Never remove the drip tray when the machine is turned on. Wait a couple of minutes after turning on/off, since the machine will be carrying out a rinse/self-cleaning cycle (see section "Rinse/Self-cleaning Cycle").

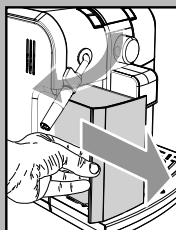
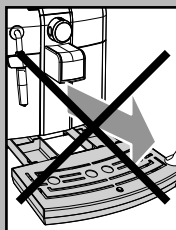
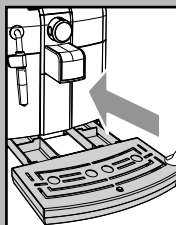

- Remove the water tank and install the Intenza water filter as recommended on page 27.
- Fill the tank with fresh drinking water. Do not exceed the "max" level indicated on the water tank. Once filled, place the tank back into the machine.

! Fill the tank only with fresh, non-sparkling water. Hot water or any other liquid may damage the tank and/or the machine. Do not turn on the machine when the tank is empty. Make sure there is enough water in the tank.

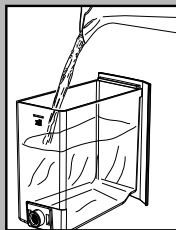

- Remove the coffee bean hopper lid.

i Note: The hopper may be provided with different safety features according to the regulations of the country of use of the machine.

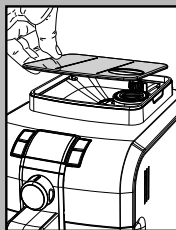

- Slowly pour the coffee beans into the hopper.

! Only coffee beans may be put into the coffee bean hopper. Ground coffee, instant coffee or any other object may damage the machine.

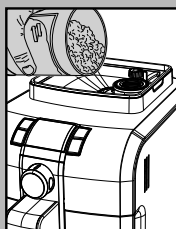

- Replace the coffee bean hopper lid.
- Insert the plug into the socket on the back of the machine.



- Insert the plug of the other end of the cable into a wall socket with suitable power voltage.

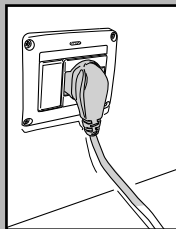

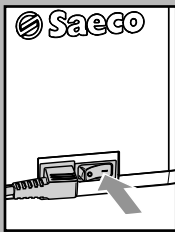

- Turn the machine ON by pressing the power switch to "I".

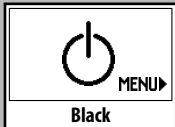

- The display shows the ON/OFF icon.

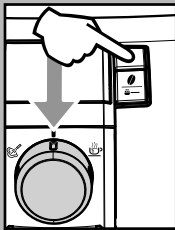

- Make sure the ON/OFF button is set to the "I" position; if this is not the case, set it to that position.
- Press the ON/OFF button to turn the machine on.

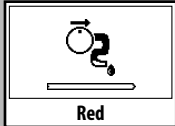

- The display indicates that the circuit must be primed.

i Note: Before starting the machine after long periods of inactivity, the water circuit must be primed.

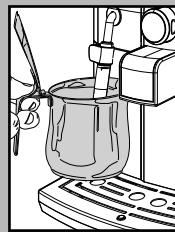

Priming the Water Circuit

- To prime the water circuit, place a container under the steam/hot water wand (Pannarello, if supplied).

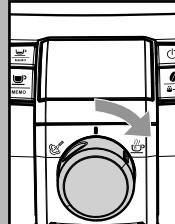

- Turn the selector dial clockwise to set it to the "☺" position. The machine starts the automatic priming of the circuit by letting out a preset quantity of water through the steam/hot water wand (Pannarello, if supplied). The bar under the icon shows the operation progress.

At the end of the priming process, the display shows an icon (see figure) indicating that the selection dial must be brought back to the central "I" position.

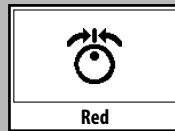

- The display then shows the machine warm-up icon, as shown in the figure.

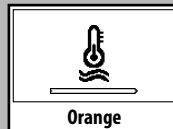

i When warm-up is complete, the machine performs a rinse cycle of the internal circuits. In this phase, this icon will be displayed:

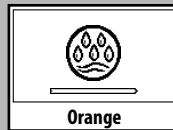

- When the operations described above are complete, this icon will be displayed:

The machine is then ready to brew beverages.

- To brew coffee, dispense hot water or steam, and for a proper use of the machine, carefully follow the instructions provided.

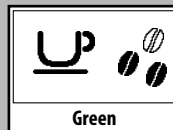

i If the machine is being used for the first time or after a long period of inactivity, follow the operations described in the following section.

Using the machine for the first time or after a long period of inactivity.

These simple operations will make it possible to always brew excellent coffee.

- 1 Place a large container under the dispensing spout.
- 2 Before starting the procedure, check that the following icon is displayed.
- 3 Select the pre-ground coffee function by pressing the “☕” button one or more times.

i Do not add the pre-ground coffee to the compartment.

The icon will appear on the display.

- 4 Press the button to brew a long coffee.
- 5 Wait until brewing is completed and empty the water tank.
- 6 Repeat the operations from step 1 to step 5 for 3 times; then continue with step 7.
- 7 Place a container under the steam wand (Pannarello, if supplied).
- 8 Turn the selector switch clockwise to set it to the “☕” position.

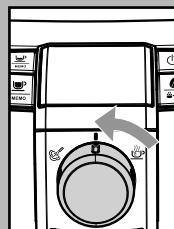
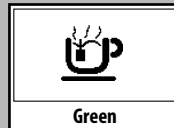
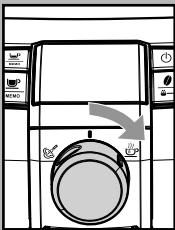
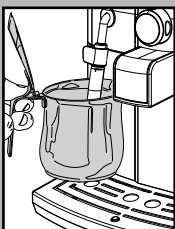
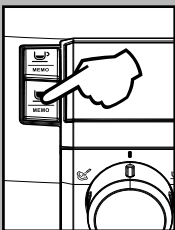
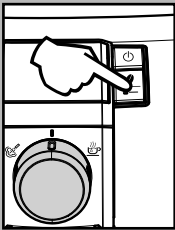
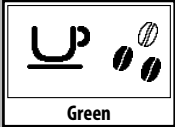
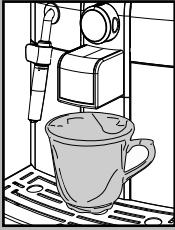

The following icon will be displayed.

- 9 Dispense water until the no water signal is displayed, then turn the selector switch counter-clockwise to set it to the “☕” position.
- 10 At the end, fill the water tank again. Then the products can be brewed as described in the following sections.

Rinse/Self-Cleaning Cycle

This cycle will rinse coffee circuits with fresh water.

The cycle is carried out:

- At machine start (with cold boiler)
- After priming the water circuit (with cold boiler)
- During the stand-by mode (if a coffee product has been brewed)
- If the machine is turned off by pressing the ON/OFF button (if a coffee product has been brewed).

A small amount of water will be dispensed to rinse and heat all the machine components; in this phase this icon is displayed:

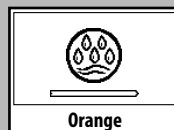

Wait for the cycle to finish automatically. **You can stop dispensing as well, by pressing either coffee button and/or the ON/OFF button.**

Water hardness measurement

The water hardness measurement is very important in order to correctly manage the “Intenza” filter and the frequency with which the machine must be descaled.

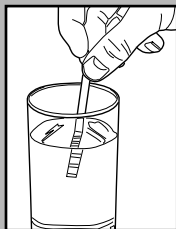

Immerse the water hardness test strip provided with the machine in water for 1 second.

i **Note: The test strip is only valid for one measurement.**

Check how many squares change colour and refer to the table.

The letters correspond to the references that are located in the base of the Intenza filter. The filter must be adjusted based on this measurement.

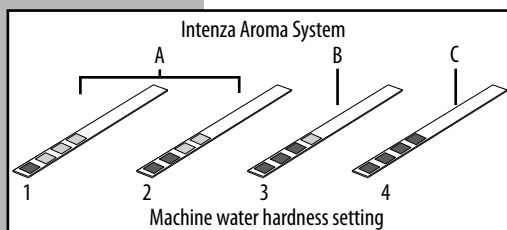

The numbers correspond to the settings that are found for the water hardness adjustment that is shown in the programming section.

More precisely:

1 = ▲ (very soft water)

2 = ▲▲ (soft water)

3 = ▲▲▲ (hard water)

4 = ▲▲▲▲ (very hard water)

Once this value is known, set the water hardness value as specified in the programming section.

Intenza Water Filter

To improve the quality of the used water, it is recommended that you install the water filter.

Remove the small white filter from the tank and store it in a dry place sheltered from dust.

Remove the water filter from its packaging, immerse it vertically (with the openings positioned upwards) in cold water and gently press its sides so as to let the air bubbles out.

Set the Intenza Aroma System as specified on the box.

A = Soft water

B = Hard water (standard)

C = Very hard water

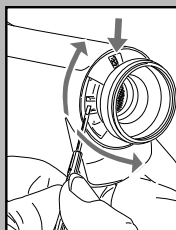

Insert the filter in the empty tank. The reference mark and the groove must match. Push firmly until it is completely inserted.

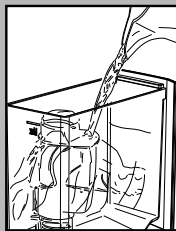

Fill the tank with fresh drinking water and re-insert it into the machine.

Dispense the water in the tank by using the hot water function (see section “Hot Water Dispensing”).

Fill the water tank again.

Press the ON/OFF button to change the machine status to stand-by mode.

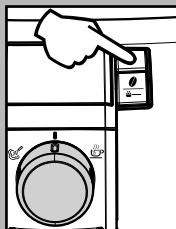

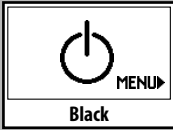

When the icon appears, press the “” button to access the machine programming menu.

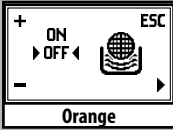

Press the “” button until the following page is displayed.

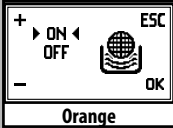

Press the “” button to select “ON” and press the “” button to confirm.

In this way, the machine has been programmed to inform the user of the need to replace the filter.



i Note: When an “Intenza” filter must be replaced with a new one, the function must be reset. Replace the filter as previously shown. After that, enter the programming menu until the indicated window is displayed and select the “RESET” option; then press the “” button. The machine is now programmed to manage a new filter.

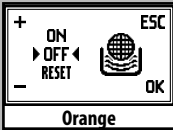

i Note: If the filter is already installed and you want to remove it, without replacing it, select the “OFF” option and then press the “” button.

To exit, press the ON/OFF button until the stand-by page is displayed.

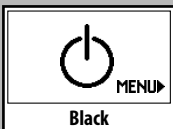

i Note: If there is no Intenza water filter, insert the small white filter previously removed into the water tank.

ADJUSTMENTS

The machine that you have bought allows for certain adjustments that will permit you to use it to its full potential.

Saeco Adapting System

Coffee is a natural product and its characteristics may change according to its origin, blend and roast. The Saeco coffee machine is equipped with a self-adjusting system that allows the use of all types of coffee beans available on the market (not including flavored or caramelized).

- The machine automatically adjusts itself in order to optimize the extraction of the coffee, ensuring perfect compression of the beans to obtain a creamy espresso coffee that is able to release all the aromas, regardless of the type of coffee used.
- The optimization process is a learning process that requires the brewing of a certain number of coffees to allow the machine to adjust the compactness of the ground coffee.
- Attention should be given to special blends, which require grinder adjustments in order to optimize the extraction of the coffee (see section “Coffee Grinder Adjustment”).

Coffee Grinder Adjustment

⚠ Warning! The grinder adjustment knob, inside the coffee bean hopper, must be turned only when the grinder is working. Do not pour ground and/or instant coffee into the coffee bean hopper.

⚠ Do not insert any material other than coffee beans into the hopper. The grinder contains moving parts that may be dangerous. Therefore, do not insert fingers and/or other objects. Only grind setting by means of the knob is permitted. Turn off the machine and unplug it from the socket before carrying out any type of operation inside the coffee

bean hopper.

Do not pour coffee beans when the coffee grinder is working.

The machine allows slight adjustments to the coffee grinder to adapt it to the kind of coffee used.

To make any adjustment, press and turn the knob inside the coffee bean hopper.

Press and turn the knob by one notch at a time and brew 2-3 cups of coffee; this is the only way to notice differences in grind.

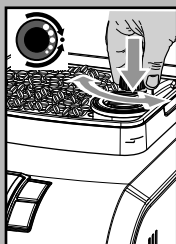



The reference marks inside the coffee bean hopper indicate the grind setting. There are 5 different grind settings to choose from with the following references:

Large Dot - Coarse Grind

Small Dot - Fine Grind

Adjusting the Coffee Quantity



The machine allows you to adjust the amount of brewed coffee according to your tastes and/or the size of your cups.

Each time you press and release button “” or “”, the machine brews a pre-programmed amount of coffee. This amount may be reprogrammed to your taste. Each button may be individually programmed for a specific brew setting.

As an example, the following procedure describes the programming of the button “”, which is normally associated with espresso coffee.

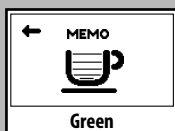
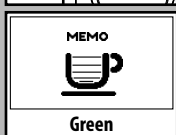
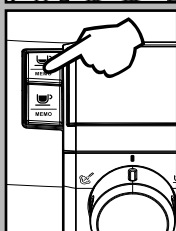
- Place a cup under the dispensing head.
- Press and hold the “” button, until the relevant icon is displayed. At this point, the machine is programming it.



- The machine begins the dispensing phase. The “” icon will be displayed to show which button is being programmed.
- Press the button with the “” icon again when the desired amount of coffee in the cup is reached.

At this point the button “” is programmed; each time it is pressed and released, the machine will brew the same amount of coffee that was just programmed.

Stand-By

The machine is designed for energy saving. The machine automatically turns off after 60 minutes of inactivity.

i Note: During the switching off phase, the machine performs a rinse cycle, if a coffee product has been brewed.

To turn the machine on again, simply press the ON/OFF button (if the power switch is set to “I”). In this case the machine will go through the rinse cycle only if the boiler is cold.

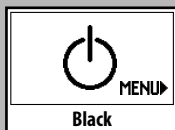

COFFEE BREWING

! Note: Should the machine not brew coffee, make sure that the water tank contains water.

i Before brewing coffee, check the messages on the display. Check that the water tank and coffee bean hopper are full.

i Leave the dial on the coffee position “” during the dispensing phase.

i Before brewing the coffee, adjust the height of the brewing head according to your needs, and select the aroma or the pre-ground coffee.

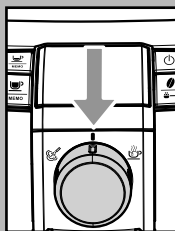
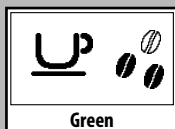

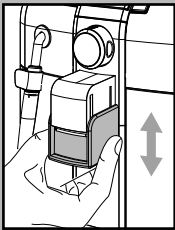

Dispensing Head Adjustment

Most cups on the market can be used with this coffee machine. The height of the dispensing head may be adjusted to better fit the dimensions of the cups that you wish to use.

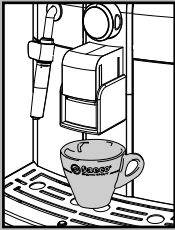

Manually move the dispensing head up or down to adjust its height by placing your fingers as shown in the figure. The recommended positions are:
For use with small cups;

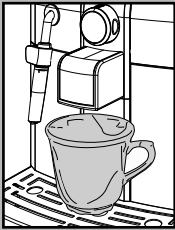

For use with big cups.

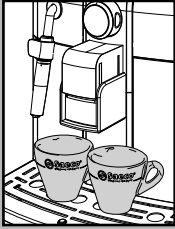

- Two cups/mugs can be placed under the dispensing head for brewing two coffees at the same time.

Aroma Adjustment

Aroma adjusts the quantity of coffee to be ground, or sets the use of pre-ground coffee.

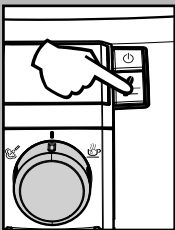

Four choices are possible by pressing and releasing the "☉" button (mild, medium or strong aroma, and ground coffee).

Selection can be made when the beans appear on the display. Each time the "☉" button is pressed and released, the aroma changes by one degree:

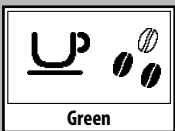

- ☉☉☉☉ = Mild aroma
- ☉☉☉ = Medium aroma
- ☉☉☉ = Strong aroma

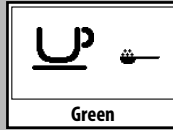

Selection must be made prior to brewing the coffee. The system sets the aroma according to the personal taste of the user.

After selecting "Strong Aroma", the function for brewing coffee with pre-ground coffee is displayed.

This selection is displayed by the icon on the side.

Refer to the relevant section to use this function.

Using Coffee Beans

- To brew coffee, press and release one of the following buttons:
the "☉" button to select the desired aroma.
the "MEMO" button for an espresso coffee;.
the "MEMO" button for a long coffee.
- The brewing cycle then starts:

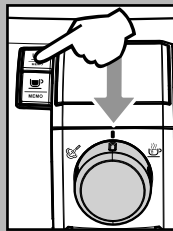

To dispense 1 cup of coffee, press the button once. This icon will be displayed:

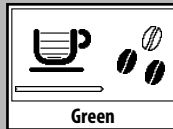

To dispense 2 cups of coffee, press the button twice. This icon will be displayed:

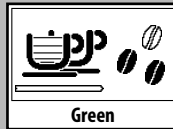

i To brew 2 coffees, the machine automatically grinds and doses the correct amount of coffee. Brewing two coffees requires two grinding cycles and two brewing cycles, which the machine carries out automatically.

- After the prebrewing cycle, coffee begins to come out of the dispensing head.
- Coffee brewing stops automatically when the pre-programmed level is reached; however, it is possible to interrupt coffee brewing by pressing the button initially pressed.

i The machine is adjusted to brew a true Italian espresso coffee. This feature may slightly lengthen the brewing time, allowing the intense flavor of the coffee to develop fully.

Using Pre-Ground Coffee

i This function allows using pre-ground and decaffeinated coffee.

Pre-ground coffee must be poured into the bypass doser positioned next to the coffee bean hopper. Only use coffee ground for espresso machines and never coffee beans or instant coffee.

i Note:

- If no pre-ground coffee is poured into the bypass doser, only water will be dispensed;
- If the dose is excessive and 2 or more measuring scoops of coffee are used, the machine will not brew the product. In this case, the machine will run an empty cycle and discharge any ground coffee into the dregdrawer.

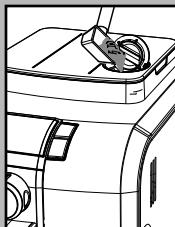
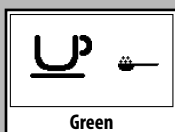
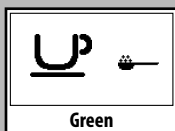

To brew coffee:

- Press and release the “☕” button to select the pre-ground coffee function.
- Lift the pre-ground bypass doser cover.
- Add only 1 scoop of pre-ground coffee to the compartment. Use the measuring scoop supplied with the machine to perform this operation. Then, close the cover.

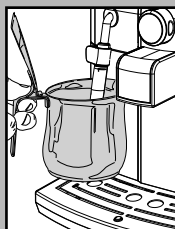
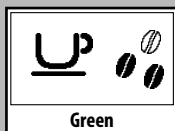

! **Warning:** Only add pre-ground coffee to the bypass doser. Other substances and objects may cause severe damages to the machine. Such damages will not be covered by warranty.

Press and release:

the “☕” button for an espresso coffee;

the “☕” button for a long coffee.

- The brewing cycle then starts. After the pre-brewing cycle, coffee begins to come out of the dispensing head.

After dispensing the product, the machine defaults back to the whole coffee bean configuration.

i Repeat the operations described above to brew other coffees.

DISPENSING HOT WATER

! **Warning:** Dispensing may be preceded by short spurts of hot water and scalding is possible. The steam/hot water wand may reach high temperatures: Do not touch with bare hands. Use the appropriate handle only.

- Before dispensing hot water, check that the following icon is displayed:

When the machine is ready, proceed as follows:

- Place a container under the steam/hot water wand (Pannarello, if supplied).

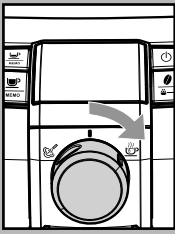

- Turn the selector dial clockwise to the “” position.



- The following icon will be displayed:

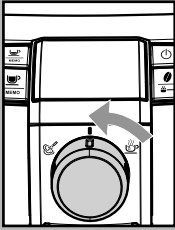

- Fill the cup with hot water to the desired level; to stop hot water dispensing, turn selector dial counter-clockwise back to the “” position. The machine returns to the normal operating mode.

i Occasionally, after turning the selector dial, hot water may not be dispensed and the following icon may be displayed: Simply wait until the end of the warm-up phase, at which point hot water will be dispensed from the wand (Pannarello if supplied).

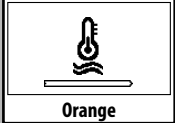

STEAM DISPENSING / CAPPUCCINO BREWING

Steam may be used to froth milk for a cappuccino, as well as to reheat other beverages.

! **Danger of scalding!** Brewing may be preceded by small spurts of hot water. The steam/hot water wand may reach high temperatures. Never touch it with bare hands.

i **Important Note:** After using the steam/hot water wand to froth milk, immediately clean the wand (or Pannarello when provided). When the machine is ready, dispense a small amount of hot water in a glass and clean the steam wand (or Pannarello when provided)

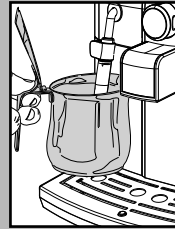

externally. In this way, all parts will be perfectly cleaned and free of any milk residue.

- Place a container under the steam/hot water wand (Pannarello, if supplied).

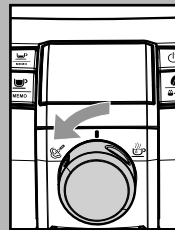

- When the machine is ready to brew coffee, turn selector dial counter-clockwise to set it onto the “” position. Residual water may dispense from the steam/hot water wand (Pannarello, if supplied).

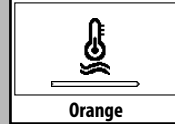

- The following icon is displayed during the preheating time required by the machine:

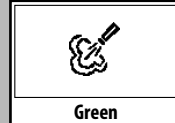

- Steam dispensing will begin when the following icon is displayed; soon after only steam will begin to come out.

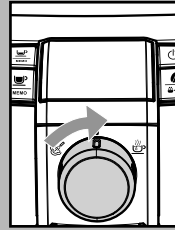

- Turn the selector dial clockwise and set it back to the “” position to stop dispensing steam.

- Fill 1/3 of the container you wish to use to prepare the cappuccino with cold milk.

i **Use cold milk for better results when preparing a cappuccino.**



Immerse the steam/hot water wand (Pannarello, if supplied) in the milk to be heated.

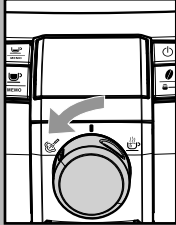

• Turn the selector dial counter-clockwise to set it to the “C” position. Froth the milk by gently swirling the cup.

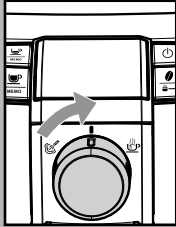

• After dispensing steam for the desired time, turn the selector dial clockwise and set it back to the “0” position to stop dispensing steam.
• The same procedure can be used to heat other beverages.

After using the steam/hot water wand (Pannarello, if supplied), wash it as described in the “Cleaning and Maintenance” section.

i After using steam to prepare a beverage, it is possible to brew coffee or to dispense steam straight after.

i If the selector dial is left on the central position “0”, the machine, in order to save energy, automatically reaches the temperature needed to dispense coffee.

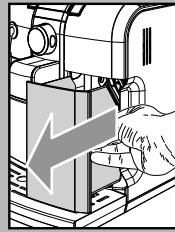

CLEANING AND MAINTENANCE

General cleaning

• Empty and clean the dregdrawer daily, with the machine turned on.

• Maintenance and cleaning operations can only be carried out when the machine is cold and disconnected from the power supply.

• Do not immerse the machine in water.
• Do not wash any of its parts in the dishwasher.

• Do not use sharp objects or harsh chemical products (solvents) for cleaning.

• Use a soft, dampened cloth to clean the machine.

• Do not dry the machine and/or its components using a microwave and/or standard oven.

i After frothing milk beverages, dispense hot water from the steam/hot water wand (Pannarello, if supplied) to obtain a thorough cleaning.

• Every day, after frothing the milk, remove the external part of the steam/hot water wand and wash it with fresh drinking water.

• Clean the steam wand weekly. In order to do this, you have to:

- Remove the external part of the Pannarello (for standard cleaning);
- Remove the upper part of the Pannarello from the steam wand;
- Wash the upper part of the Pannarello with fresh drinking water;
- Wash the steam wand with a wet cloth and remove any milk residue;
- Replace the upper part in the steam wand (make sure it is completely inserted).

Reassemble the external part of the Pannarello.

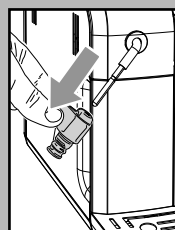
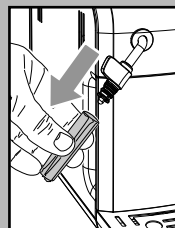

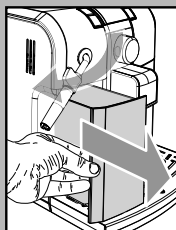

- It is recommended to clean the water tank daily.
 - Remove the small white filter in the water tank and wash it under running drinking water.
 - Reposition the small white filter in its housing by gently pressing and turning it at the same time.
 - Fill the water tank with fresh drinking water.
- Empty and clean the drip tray daily. Perform this operation also when the float is raised.

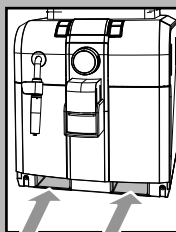
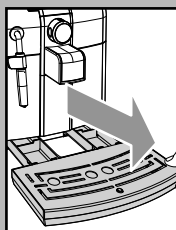

- Also clean the seat of the tray every week through the openings on the bottom of the machine.

Brew Group

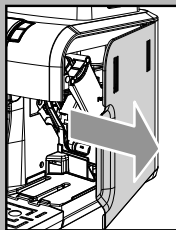

- The brew group must be cleaned at least once a week.
- Turn off the machine by pressing the ON/OFF button and remove the plug from the socket.
- Remove the dregdrawer. Open the service door.
- To remove the brew group, pull it by the handle and press the «PUSH» button. The brew group must be washed only with lukewarm water, no detergent/soap is necessary.

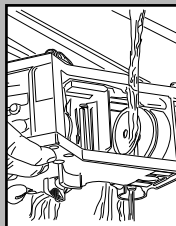
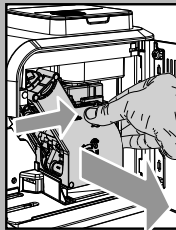

- Wash the brew group with lukewarm water and carefully clean the upper filter.
- Thoroughly wash and dry all the parts of the brew group.
- Thoroughly clean the inside of the machine.

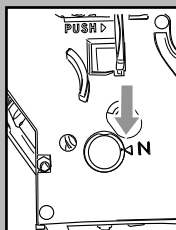

- Make sure that the brew group is in rest position. The two references must match.

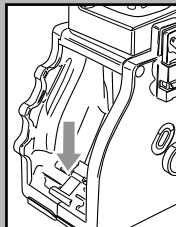

- The lever on the rear part of the brew group must be in contact with the base. Press the «PUSH» button to make sure that the brew group is in the correct position.

i Lubricate the brew group after approximately 500 brewing cycles. The brew group lubricant may be purchased at authorized service centers.

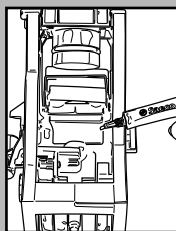

- Lubricate the brew group guides using the supplied lubricant only.

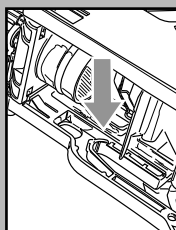

- Apply the lubricant evenly on both side guides.

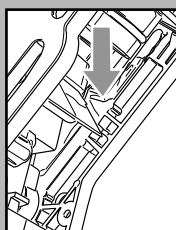

- Insert the brew group in its seat until it locks into place WITHOUT pressing the «PUSH» button.

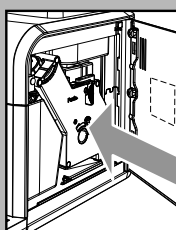

- Insert the dregdrawer. Close the service door.

DESCALING

Limescale build-up is normal with the use of this appliance.

The display informs you when descaling is necessary:

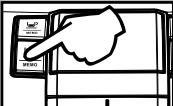
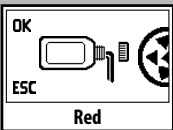
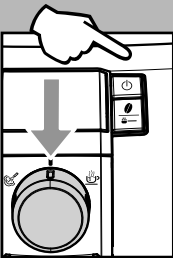
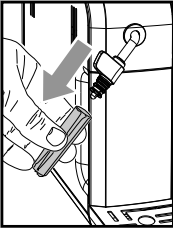
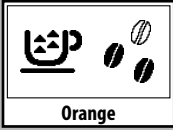

i Only use the Saeco descaling solution. It has been specifically developed to preserve performance and functionality throughout the lifetime of the machine and to ensure, with regular use, a high quality delivered product.

! Warning! Never drink the descaling solution or any products dispensed until the cycle has been carried out to the end. Never use vinegar as a descaling solution.

Before descaling, remove the Pannarello attachment from the steam/hot water wand as described in the "Cleaning and Maintenance" section.

• Turn the machine on by pressing the ON/OFF button. **Wait for the machine to finish its rinse cycle and warm up.**

! Warning! Remove the Intenza filter before adding the descaling solution.

• Hold the "☉" button for 5 seconds. The display will show the icon on the side.

i If you press the "☉" button by mistake, use the "MEMO" button to quit.

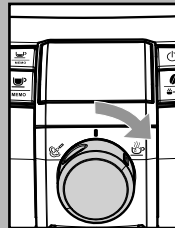
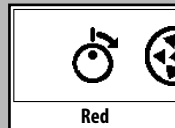
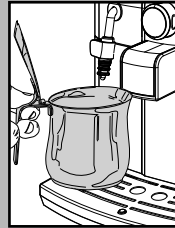
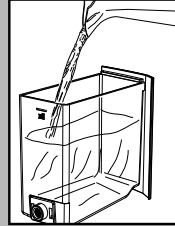
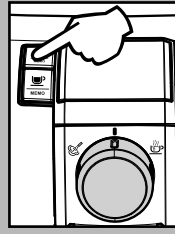

• Press button "MEMO" to confirm the activation of the descaling cycle.

i From this point forward, the descaling cycle must be completed before proceeding.

• Pour the entire content of the Saeco concentrated descaling solution into the water tank, and then fill the tank with fresh drinking water up to the MAX level. Place the tank back in the machine.

• Insert a container below the steam/hot water wand.

i Use a large container for this process. If you do not have a container of this capacity, once it is filled close the knob, empty the container and then place it again under the wand and repeat the procedure.

• After adding the descaling solution in the tank, turn the selector dial clockwise to position "☉" to start the descaling cycle.

• The machine will start dispensing, at regular intervals, the descaling solution (the bar shows the cycle progress).

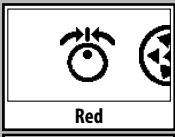

Red

- When the solution in the tank is finished dispensing, the icon on the side is displayed to indicate that the selector dial must be brought back to the "0" position.

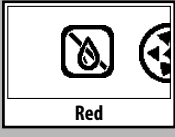
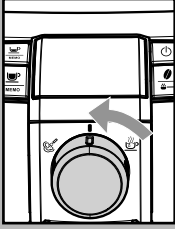

Red

- The icon indicates that the tank must be rinsed and filled. Rinse the water tank thoroughly and refill it with fresh drinking water.
- Empty the container used to collect the liquid dispensed by the machine and place it under the steam wand.

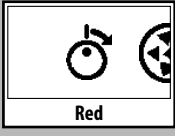

Red

- When inserting the tank filled with water in the machine, the icon on the side is displayed; turn the selector dial clockwise to position "☺".



Red

- The machine starts the rinse cycle.

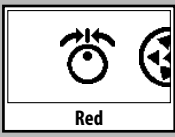

Red

- When the water in the tank is finished dispensing, the icon on the side is displayed to indicate that the selector dial must be brought back to the "0" position.

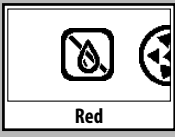

Red

- The icon indicates that the tank must be rinsed and filled. Rinse the water tank thoroughly and refill it with fresh drinking water.
- Empty the container used to collect the liquid dispensed by the machine and place it under the steam wand.

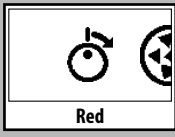

Red

- When inserting the water tank in the machine, turn the selector switch clockwise to position "☺". Dispense the entire tank as previously described. At the end, fill the tank again.

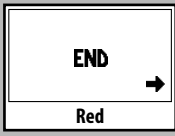

Red

- When inserting the water tank again, the icon on the side is displayed. Press the "☺" button to exit the descaling cycle.
- The machine now carries out the warm-up and rinse cycle to prepare for product brewing.
- Empty the container used to collect the liquid dispensed by the machine.

i The descaling solution must be disposed of according to the manufacturer's instructions and/or regulations in force in the country of use.

i After completing the descaling cycle, wash the brew group as described in the "Brew group" section in the "Cleaning and maintenance" section.

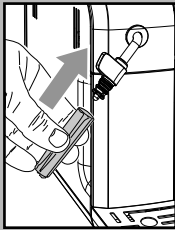

Reassemble the external part of the Pan-narello.

PROGRAMMING

The user can change some of the machine operating parameters to suit his/her needs.

Enter the "menu"

The programming menu can only be accessed when the machine is in "stand-by" mode.

To change the machine status to stand-by mode, press the ON/OFF button.

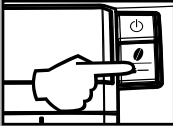
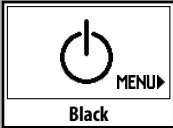
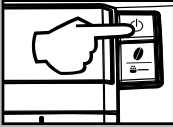

When the machine is in stand-by mode, press the "MENU" button to access programming.

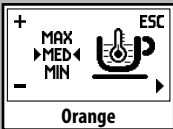

The first page that is displayed is shown here.

Programming commands

Changes can be made on each page:

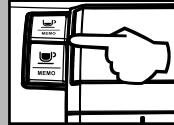
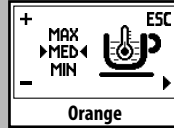

- The "MEMO" and "MEMO" buttons allow you to change the value of the function, among those appearing on the page.

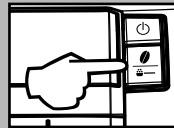

- The "scroll" button allows you to scroll the functions and to store the changes that were made.

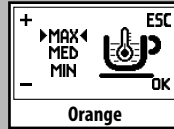

i Note: Changes can be stored only after the displayed value is changed; when the displayed value is changed the "OK" message appears.

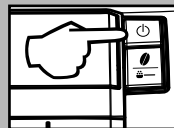

- The "ON/OFF" button allows you to exit the change or programming mode.

Exit programming mode

To exit the programming mode, press the ON/OFF button until the stand-by page is displayed.

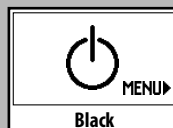

i Note: The machine will exit the programming mode if the user does not do anything for 30 seconds. The settings that were changed but not confirmed will not be stored.

Functions

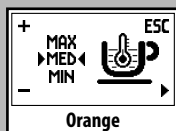

COFFEE TEMPERATURE

This function allows you to adjust the coffee brewing temperature.

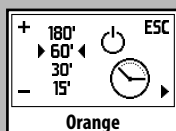

TIMER (STAND-BY)

This function allows you to adjust the time the machine will go into stand-by mode after the last brewing.

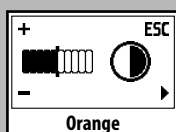

CONTRAST

This function allows you to adjust the contrast of the display to better view the messages.

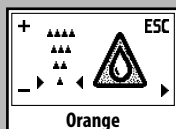

WATER HARDNESS

This function allows you to adjust the water hardness in order to better manage machine maintenance:

▲ = very soft water

▲▲ = soft water

▲▲▲ = hard water

▲▲▲▲ = very hard water

i For more details, see the "Water hardness measurement" section.

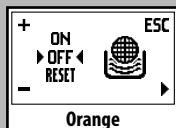

"INTENZA" WATER FILTER

This function allows you to manage the "Intenza" water filter.

For more details, see the section related to filter handling.

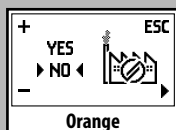

FACTORY SETTINGS

This function allows you to reset all factory values.

Programming example

In this example, we want to explain how to programme the display contrast. Proceed in a similar manner to change the other functions.

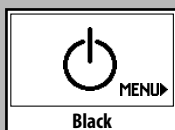

Change the machine status to stand-by mode.



When the machine is in stand-by mode, press the "MENU" button to access programming.

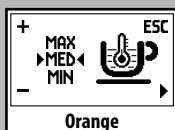

The first page is displayed.

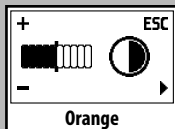

Press the "MEMO" button until the "CONTRAST" function is displayed.

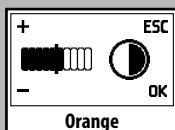

Press the "MEMO" button 1 (one) time to increase the contrast.

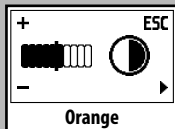

Press the "MEMO" button to confirm.



Press the "ON/OFF" button to exit the programming mode.

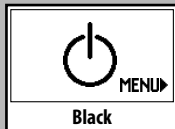

At this point, the function is programmed and will be active the next time the machine is started.

CONTROL PANEL DISPLAY

Ready Signals

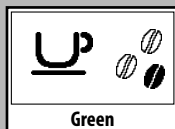

- The machine is ready for whole bean coffee brewing and hot water dispensing.



- The machine is ready for pre-ground coffee brewing.



- The machine is in the steam dispensing phase.



- The machine is in the hot water dispensing phase.

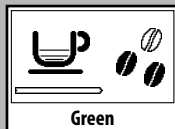

- The machine is brewing 1 espresso coffee.

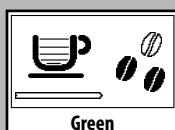

- The machine is brewing 1 long coffee.



- The machine is brewing 2 espresso coffees.

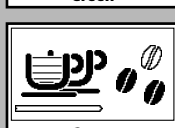

- The machine is brewing 2 long coffees.

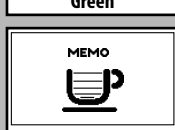

- The machine is programming the amount of coffee to be brewed.



Warning Signals

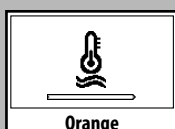

- The machine is warming up to brew coffee and dispense hot water or steam.



- The machine is performing the rinse cycle. Wait until the machine automatically stops brewing the beverage.

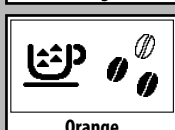

- The machine must be descaled.

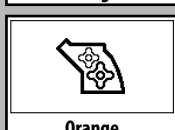

- The brew group is being reset due to machine reset.

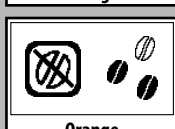

- The coffee bean hopper needs to be refilled with coffee beans to restart the brewing cycle.

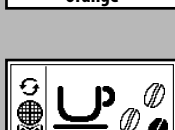

- The Intenza filter must be replaced with a new one.

i This message will only be displayed if the function is activated in the programming mode.

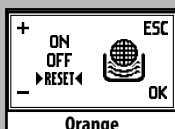

The alarm is deactivated only if it is "RESET" in the programming mode.

Alarm Signals

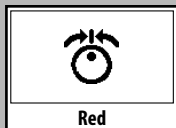

- Return the hot water / steam knob to its proper position.

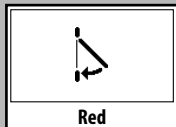

- Close the service door.



- Refill the coffee bean hopper.

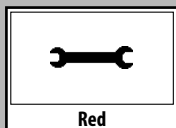

- Turn the machine off. After 30-seconds, turn it back on. Try 2 or 3 times.
If the machine does NOT start, contact an authorized service center.

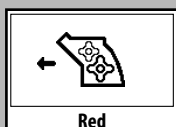

- Insert the brew group in the machine.

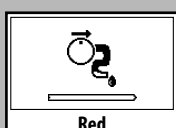

- Problems with the water circuit.

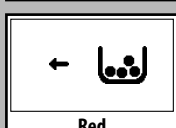

- Insert the dregdrawer.

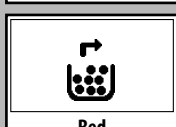

- Empty the dregdrawer and the drip tray.

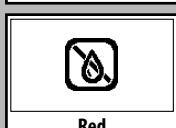

- Fill the water tank.

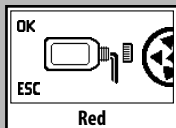

- Start screen for descaling cycle activation. Press "OK" to continue or "ESC" to quit.

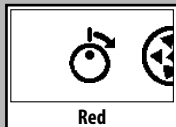

- Open the knob to carry out the operation described.



- Descaling cycle in progress.

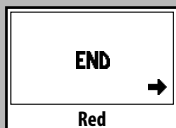

- Descaling cycle ended. Press the "END" button to quit the descaling cycle.

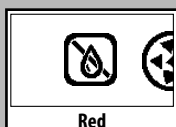

- Fill the water tank.

TROUBLESHOOTING

| Machine Actions | Causes | Solutions |
|--|---|---|
| The machine does not turn on. | The machine is not connected to the power source. | Connect the machine to the power source. |
| The coffee is not hot enough. | The cups are cold. | Warm the cups with hot water. |
| No hot water or steam is dispensed. | The hole of the steam wand is clogged. | Clean the hole of the steam wand using a pin. Make sure that the machine is turned off and has cooled before performing this operation. |
| | Pannarello is dirty (if supplied). | Clean the Pannarello. |
| The coffee has little crema. (see note) | The coffee blend is unsuitable, the coffee is not freshly roasted or the grind is too coarse. | Change coffee blend or adjust the grind as explained in the "Coffee Grinder Adjustment" section. |
| The machine takes a long time to warm up or the amount of water dispensed from the wand is too little. | The machine circuit is obstructed by limescale build-up. | Descale the machine. |
| The brew group does not come out. | The brew group is out of place. | Turn the machine on. Close the service door. The brew group automatically returns to the correct position. |
| | Dregdrawer is inserted. | Remove the dregdrawer first, then the brew group. |
| The machine grinds the coffee beans but no coffee comes out. (See note) | Water tank is empty. | Fill the water tank and prime the circuit (section "Using the Machine for the First Time"). |
| | Brew group is dirty. | Clean the brew group (section "Brew Group"). |
| | Circuit is not primed. | Prime the circuit (section "Using the Machine for the First Time"). |
| | Rare event that occurs when the machine is automatically adjusting the dose. | Brew a few coffees as described in section "Saeco Adapting System". |
| | The dispensing head is dirty. | Clean the dispensing head. |
| The coffee is too weak. (see note) | Rare event that occurs when the machine is automatically adjusting the dose. | Brew a few coffees as described in section "Saeco Adapting System". |
| Coffee is brewed slowly. (see note) | The coffee grind is too fine. | Change coffee blend or adjust the grind as explained in the "Coffee Grinder Adjustment" section. |
| | The circuit is not primed. | Prime the circuit (section "Using the Machine for the First Time"). |
| | The brew group is dirty. | Clean the brew group (section "Brew Group"). |
| Coffee leaks out of the dispensing head. | The dispensing head is clogged. | Clean the dispensing head and its holes. |

Note: These problems can be considered normal if the coffee blend has been changed or if the machine has just been installed. In this case wait until the machine performs a self-adjusting operation as described in section "Saeco Adapting System".

Please contact Saeco Customer Service or an authorized service center for any problems not covered in the above table or when the suggested solutions do not solve the problem.

TECHNICAL SPECIFICATIONS

The manufacturer reserves the right to make changes to the technical specifications of the product.

| | |
|--|---|
| Nominal Voltage - Power Rating - Power Supply | See label on the inside of the service door |
| Housing material | Thermoplastic material/Metal |
| Size (w x h x d)..... | 10" x 12.5" x 16" (256 x 315 x 415 mm) |
| Weight | 20 lbs. (9 kg) |
| Power Cord Length | 47" (1.2m) |
| Control Panel | Front side |
| Pannarello (only available for certain models) | Special for cappuccinos |
| Water tank | 1.2 litres – Removable type |
| Coffee Bean Hopper Capacity..... | 9.2 oz. (260 g) |
| Dregdrawer Capacity | 8 |
| Pump pressure | 15 bar |
| Boiler | Stainless steel type |
| Safety Mechanisms | Thermal fuse |

English

MACHINE DISPOSAL

- The packing materials can be recycled.
- Appliance: Unplug the appliance and cut the power cord.
- Deliver the appliance and power cord to a service center or public waste disposal facility.

This product complies with eu directive 2002/96/ec.



The symbol on the product or on its packaging indicates that this product may not be treated as household waste. Instead it shall be handed over to the applicable collection point for the recycling of electrical and electronic equipment.

By ensuring this product is disposed of correctly, you will help prevent potential negative consequences for the environment and human health, which could otherwise be caused by inappropriate waste handling of this product. For more detailed information about recycling of this product, please contact your local city office, your household waste disposal service or the shop where you purchased the product.

EC DECLARATION OF CONFORMITY
YEAR 09
EC 2006/95, EC 2004/108,

SAECO INTERNATIONAL GROUP S.P.A

Via Torretta, 240 - 40041 Gaggio Montano (Bo) - Italy

declare under our responsibility that the product :

AUTOMATIC COFFEE MAKER

SUP 037DR

to which this declaration relates is in conformity with the following standards or other normative documents :

- Safety of household and electrical appliances - General requirements EN 60335-1(2002) + A1(2004) + A2(2006) + A11(2004) + A12(2006) + A13(2008)
- Safety of household and electrical appliances - Part 2-15 Particular requirements for appliances for heating liquids EN 60335-2-15 (2002) + A1(2005) + A2 (2008)
- Household and similar electrical appliances - Electromagnetic fields - methods for evaluation and measurement - EN 62233 (2008).
- Household and similar electrical appliances - safety - Part 2-14 Particular requirements for kitchen machines - EN 60335-2-14 (2006) + A1 (2008).
- Electromagnetic compatibility (EMC) - Requirements for household appliances , electric tools and similar apparatus - Part 1 - Emission EN 55014-1 (2006).
- Electromagnetic compatibility (EMC) - Part. 3^ Limits - Section 2 : Limits for harmonic current emissions (equipment input current ≤ 16A for phase) EN 61000-3-2 (2006)
- Electromagnetic compatibility (EMC) - Part 3^ : Limits - Section 3 : Limitation of voltage changes , voltage fluctuations and flicker in public low - voltage supply systems , for equipment with rated current ≤ 16 A for phase and not subject to conditional connection EN 61000-3-3 (1995)+ corr.(1997) +A1 (2001) + A2 (2005).
- Electromagnetic compatibility - Requirements for household appliances , electric tools and similar apparatus - Part 2. Immunity - Product family standard EN 55014-2 (1997) + A1 (2001)

following the provisions of the Directives: EC 2006/95 , EC 2004/108.

Gaggio Montano
li, 28/04/2009

R & D Manager

Mr. Andrea Castellani



www.philips.com/saeco

The manufacturer reserves the right to change the features of the product without prior notice.



Type HD8836 / HD8837 - Cod.15002481 Rev.00 del 15-03-10